



M-2300-M Mustang GT Rear Disc Brake Bracket Kit INSTALLATION INSTRUCTIONS

NO PART OF THIS DOCUMENT MAY BE REPRODUCED WITHOUT PRIOR AGREEMENT AND WRITTEN PERMISSION OF FORD RACING PERFORMANCE PARTS.

Please visit www.fordracingparts.com for the most current instruction information

**!!! PLEASE READ ALL OF THE FOLLOWING INSTRUCTIONS CAREFULLY PRIOR TO INSTALLATION.
AT ANY TIME YOU DO NOT UNDERSTAND THE INSTRUCTIONS, PLEASE CALL THE FORD RACING
TECHLINE AT 1-800-367-3788 !!!**

INTRODUCTION:

This kit allows for the installation of Cobra or Bullitt rear calipers, part numbers M-2320-CR and M-2320-R respectively. The components in this kit will improve the braking performance of your 1994-04 Mustang GT. This kit requires the use of 17" x 8" wheels (not included in this kit), with a 5 lug, 4.5" diameter mounting pattern. For road use, a 5 lug, 4.5" diameter spare wheel/tire that clears calipers in front and rear is also required. The 1994-95 Cobra mini spare, (F4ZZ-1K007-C), is available for purchase from Ford Dealers.

The installation of this kit can be performed by anyone with an average amount of mechanical experience, but it is very important to follow the instructions and refer to the 1994-95 Mustang Shop Manual or equivalent. If you do not feel comfortable after reading the instructions and the shop manual, have the installation performed by an experienced mechanic.

!!! Caution: Improper installation of this kit could adversely affect the safety of your vehicle !!!

PARTS IN KIT:

<u>ITEM #</u>	<u>QTY</u>	<u>DESCRIPTION</u>	<u>SERVICE PART #</u>	<u>REPLACEMENT SOURCE</u>
1	1	ADAPTER, CALIPER TO AXLE L.R.	F4ZZ-2C101-B	F/L/M DEALER
2	1	ADAPTER, CALIPER TO AXLE R.R.	F4ZZ-2C100-B	F/L/M DEALER
3	2	DUST SHIELD	F4ZZ-2C028-A	F/L/M DEALER
4	6	BOLTS, DUST SHIELD	N602726-S2	F/L/M DEALER
5	2	ROTOR, REAR	F4ZZ-2C026-B	F/L/M DEALER
6	1	MOAN BRACE, R.R.	F4ZZ-2C366-A	F/L/M DEALER
7	1	MOAN BRACE, L.R.	F4ZZ-2C367-A	F/L/M DEALER

Factory Ford shop manuals are available from Helm Publications, 1-800-782-4356



M-2300-M Mustang GT Rear Disc Brake Bracket Kit INSTALLATION INSTRUCTIONS

NO PART OF THIS DOCUMENT MAY BE REPRODUCED WITHOUT PRIOR AGREEMENT AND WRITTEN PERMISSION OF FORD RACING PERFORMANCE PARTS.

TOOLS REQUIRED: Stud and Bearing Mount E0AZ-19554-BA tool or equivalent

Cobra/Mustang Shop Manual

Torque wrench

Power brake bleeder* (not mandatory but recommended)

Stud and Bearing Mount E0AZ-19554-BA tool or equivalent

* Bench bleeding calipers before installation is recommended.

SERVICE PRECAUTIONS:

1. Grease or any other foreign material must be kept off lining surfaces and braking surfaces of the rotor, and external surfaces of hub during service operation. In handling rotor and caliper assemblies, avoid deformation, nicking or scratching of brake linings and rotor.
2. If a caliper piston is removed for any reason, piston seal and dust boot must be replaced. Exercise care not to damage steel piston by protecting it from contact with any metal or sharp edged objects.
3. During removal and installation of a wheel assembly, exercise care not to interfere with or damage caliper splash shield, if so equipped, or the bleeder screw fitting.
4. Vehicle must be centered on hoist before servicing any front end components to avoid bending or damaging rotor splash shield, if so equipped, on full right or left wheel turns.
5. Do not attempt to clean or restore oil or grease-soaked brake lining. When contaminated linings are found, brake linings must be replaced in complete axle sets and rotor braking surfaces wiped clean.
6. The LH and RH calipers must be installed on the correct side of the vehicle to be sure the bleed screw is in the topmost position for proper purging of air from the front brake system during bleeding.

!!! Warning: Do not inhale dust from brakes, clutches or associated components. Inhalation of dust containing asbestos fibers can be injurious to your health and could cause cancer or asbestosis. Compressed air or brushes must not be used to clean brakes, brake drums, clutches and associated components. A vacuum cleaner equipped for this purpose should be carefully used to remove any dust. Adherent dust should be removed with a damp cloth. Any dust should be contained in a sealed and labeled bag for disposal. Wear an approved high efficiency cartridge or air-line respirator and use extra caution to avoid breathing this dust. Use non-asbestos replacement parts whenever possible !!!

!!! Warning: Brake fluid contains polyglycol ethers and polyglycols. Avoid contact with eyes. Wash hands thoroughly after handling. If brake fluid contacts eyes, flush eyes with running water for 15 minutes. Get medical attention if irritation persists. If taken internally, drink water and induce vomiting. Get medical attention immediately !!!

Factory Ford shop manuals are available from Helm Publications, 1-800-782-4356



M-2300-M Mustang GT Rear Disc Brake Bracket Kit INSTALLATION INSTRUCTIONS

NO PART OF THIS DOCUMENT MAY BE REPRODUCED WITHOUT PRIOR AGREEMENT AND WRITTEN PERMISSION OF FORD RACING PERFORMANCE PARTS.

TORQUE SPECIFICATIONS:

FASTENER	TORQUE (FT./LBS.) (EXCEPT WHERE NOTED)
DIFFERENTIAL PINION SHAFT LOCKING BOLT	15-30
BANJO BOLTS	30-40
WHEEL NUTS	85-105
DUST SHIELD ATTACHING BOLTS	6-9
AXLE ADAPTER/REARBACKING PLATE BOLTS	45-50
AXLE HOUSING COVER BOLTS	25-35
AXLE FILL PLUG	15-30
REAR MOAN BRACE U-BOLT NUTS	40-45
ANTI LOCK SPEED SENSOR	<i>40-60 in./lbs.</i>
CALIPER MOUNTING BOLTS	70-95

Factory Ford shop manuals are available from Helm Publications, 1-800-782-4356



M-2300-M Mustang GT Rear Disc Brake Bracket Kit INSTALLATION INSTRUCTIONS

NO PART OF THIS DOCUMENT MAY BE REPRODUCED WITHOUT PRIOR AGREEMENT AND WRITTEN PERMISSION OF FORD RACING PERFORMANCE PARTS.

REAR BRAKE INSTALLATION INSTRUCTIONS:

Note: Refer to the shop manual for the recommended procedures to remove and install axle shafts, rear brake components and brake lines.

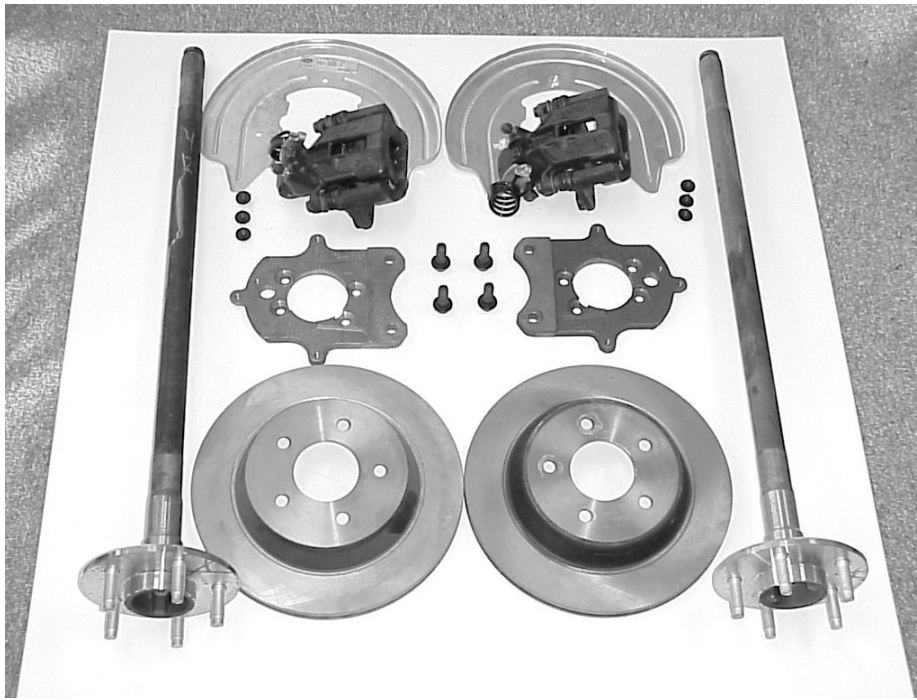

Note: Calipers and axles are not included in this kit. Cobra Caliper kit part number M-2320-CR and Bullitt caliper kit part number M-2320-R

Factory Ford shop manuals are available from Helm Publications, 1-800-782-4356



M-2300-M Mustang GT Rear Disc Brake Bracket Kit INSTALLATION INSTRUCTIONS

NO PART OF THIS DOCUMENT MAY BE REPRODUCED WITHOUT PRIOR AGREEMENT AND WRITTEN PERMISSION OF FORD RACING PERFORMANCE PARTS.

- STEP 1:** Disconnect battery.
- STEP 2:** Raise vehicle off ground and support with jack stands.

!!! Caution: Be sure to support the vehicle properly to avoid personal hazards !!!

- STEP 3:** Remove wheel cover and wheel.
- STEP 4:** Remove anti-lock speed sensor, if equipped.
- STEP 5:** Remove axle housing cover from the rear axle and drain lubricant.
- STEP 6:** Working through cover opening, remove differential pinion shaft locking bolt and remove the differential pinion shaft.
- STEP 7:** Push axle shafts inward until rear axle shaft retaining u-washers at button end of the axle shaft are clear of the side gear recess.

!!! Caution: Care should be taken not to damage inner wheel bearing oil seals when removing axle shafts from rear axle housing. !!!

- STEP 8:** Remove rear axle shaft retaining u-washers and pull the axle shafts out of the rear axle housing.
- STEP 9:** Remove parking brake cables, rear calipers and brake lines. Parking brake cables, rear caliper bolts and brake lines will be reused.

Factory Ford shop manuals are available from Helm Publications, 1-800-782-4356

M-2300-M Mustang GT Rear Disc Brake Bracket Kit INSTALLATION INSTRUCTIONS

NO PART OF THIS DOCUMENT MAY BE REPRODUCED WITHOUT PRIOR AGREEMENT AND WRITTEN PERMISSION OF FORD RACING PERFORMANCE PARTS.

STEP 10: Remove production caliper to axle adapter. Rear axle should look as shown below.

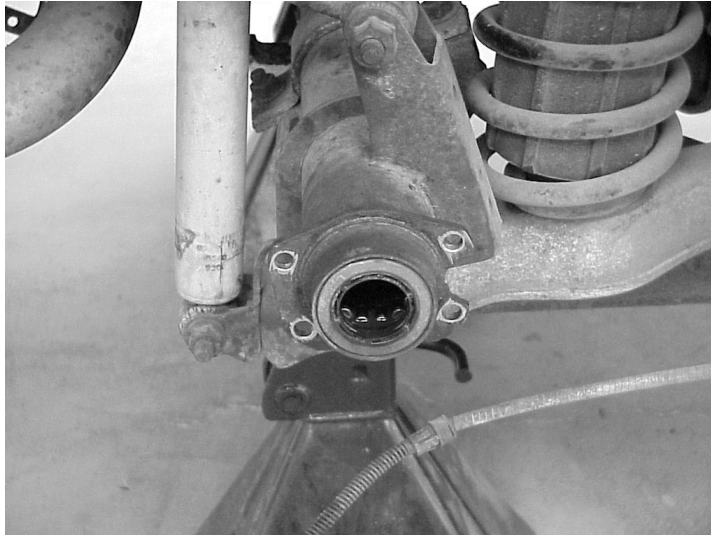

STEP 11: Reusing the backing plate bolts, install the caliper to axle adapters (item 1 and 2). Torque bolts to 45-50 ft./lbs. Axle adapters are marked LH and RH. The RH is shown below.

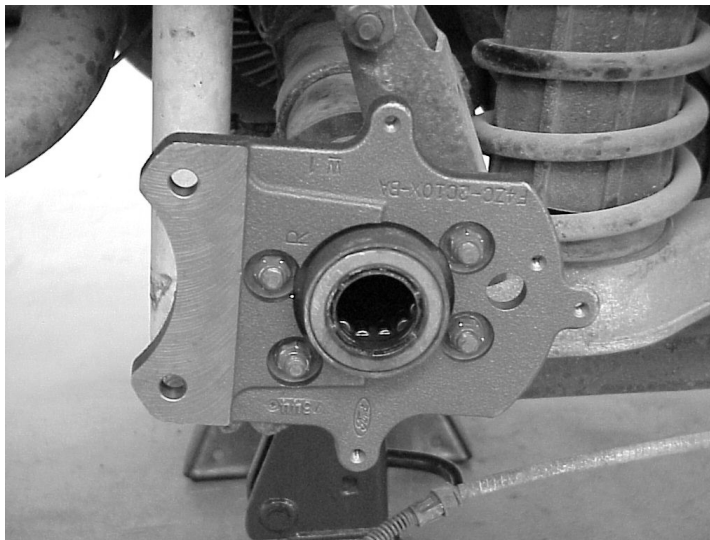

M-2300-M Mustang GT Rear Disc Brake Bracket Kit INSTALLATION INSTRUCTIONS

NO PART OF THIS DOCUMENT MAY BE REPRODUCED WITHOUT PRIOR AGREEMENT AND WRITTEN PERMISSION OF FORD RACING PERFORMANCE PARTS.

- STEP 12:** Using the three 6mm bolts (item 4), mount the dust shields (item 3) as shown below. Tighten bolts 6-9 ft./lbs.

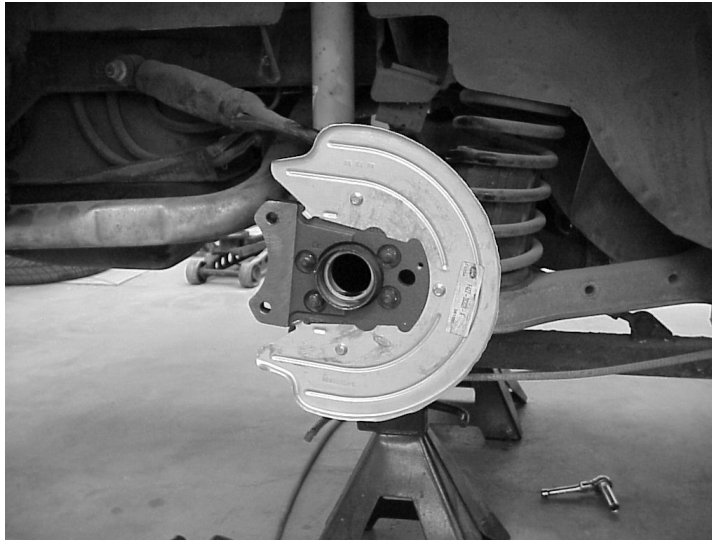

!!! Caution: Care must be taken not to let axle shaft splines damage inner wheel bearing oil seals or rear wheel bearing assembly. !!!

- STEP 13:** Carefully slide LH axle shaft into rear axle housing, without damaging rear wheel bearing or inner wheel bearing oil seal assembly. Start splines into differential side gear and push firmly until the button end of the axle shaft can be seen in the differential case.
- STEP 14:** Reinstall the rear axle shaft retaining u-washer on the button end of the axle shaft splines, then push the axle shaft outboard until the shaft splines engage and the rear axle shaft retaining u-washer seats in the counter bore of the differential side gear.
- STEP 15:** Repeat steps 13 and 14 to install the RH axle shaft.
- STEP 16:** Position the differential pinion shaft through the differential case and differential pinion gears, aligning the hole in the shaft with the differential pinion shaft locking bolt hole. Install differential pinion shaft locking bolt and tighten to 15-30 ft./lbs.
- STEP 17:** Re-install anti-lock sensors and tighten to 40-60 in./lbs.



M-2300-M Mustang GT Rear Disc Brake Bracket Kit INSTALLATION INSTRUCTIONS

NO PART OF THIS DOCUMENT MAY BE REPRODUCED WITHOUT PRIOR AGREEMENT AND WRITTEN PERMISSION OF FORD RACING PERFORMANCE PARTS.

!!! Caution: Differential pinion shaft locking bolt must be tightened to specification using Stud and Bearing Mount EOAZ-19554-BA tool and Loctite™. !!!

STEP 18: Clean axle housing cover and mating surface on the axle housing.

!!! Caution: Inside of axle must be covered when cleaning the axle housing surface to prevent contamination.

STEP 19: Apply a continuous bead of Silicone Rubber sealer recommended for axle housings to the axle housing mating surface.

Note: The axle housing cover assembly must be installed within 15 minutes of application of the silicone rubber or new silicone rubber must be applied. Tighten axle housing cover bolts in a crosswise pattern to ensure uniform draw on the axle housing. !!!

STEP 20: Install axle housing cover and tighten axle housing cover bolts to 28-38 ft./lbs.

STEP 21: Add Rear Axle Lubricant XY-90-QL or -KL or equivalent meeting Ford specification ESP-M2C154-A until it is 6-14mm (1/4-9/16 inch) below bottom of fill hole.

STEP 22: Add 118ml (4 oz) of Additive Friction Modifier C8AZ-19B546-A or equivalent meeting Ford specification EST-M2C118-A for Traction-Lok axles.

STEP 23: Install fill plug and tighten to 15-30 ft./lbs.

Factory Ford shop manuals are available from Helm Publications, 1-800-782-4356

M-2300-M
Mustang GT Rear Disc Brake Bracket Kit
INSTALLATION INSTRUCTIONS

NO PART OF THIS DOCUMENT MAY BE REPRODUCED WITHOUT PRIOR AGREEMENT AND WRITTEN PERMISSION OF FORD RACING PERFORMANCE PARTS.

STEP 24: Slide LH and RH caliper brace u-bolts (Item 6 and Item 7) around axle tube as shown below.



STEP 25: Slide the caliper brace into place over the U-bolt as shown and loosely install the nuts.



STEP 26: Install new rear rotors (Item 5) on the axle using a lug nut to temporarily hold the rotor in place.



M-2300-M Mustang GT Rear Disc Brake Bracket Kit INSTALLATION INSTRUCTIONS

NO PART OF THIS DOCUMENT MAY BE REPRODUCED WITHOUT PRIOR AGREEMENT AND WRITTEN PERMISSION OF FORD RACING PERFORMANCE PARTS.

STEP 27: Install calipers (not included in kit) over the rotor as shown using the bolts coated with Loctite™ and torque to 70-95 ft./lbs.

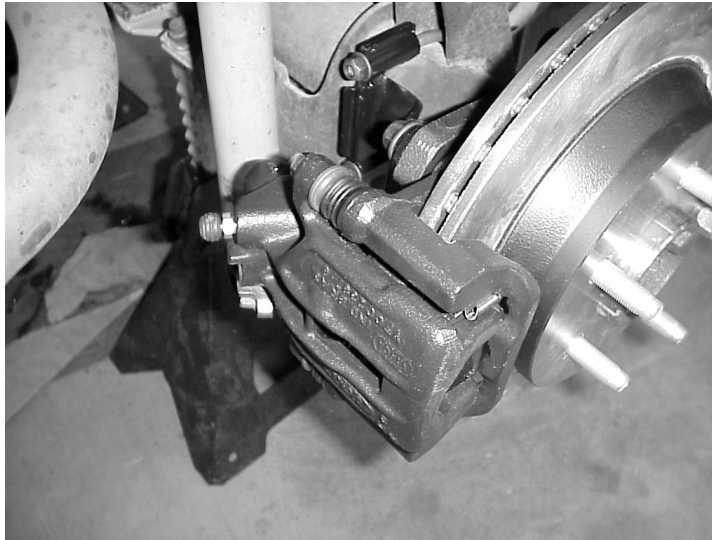

STEP 28: Tighten U-bolts evenly to a torque of 40-45 ft./lbs. as shown.

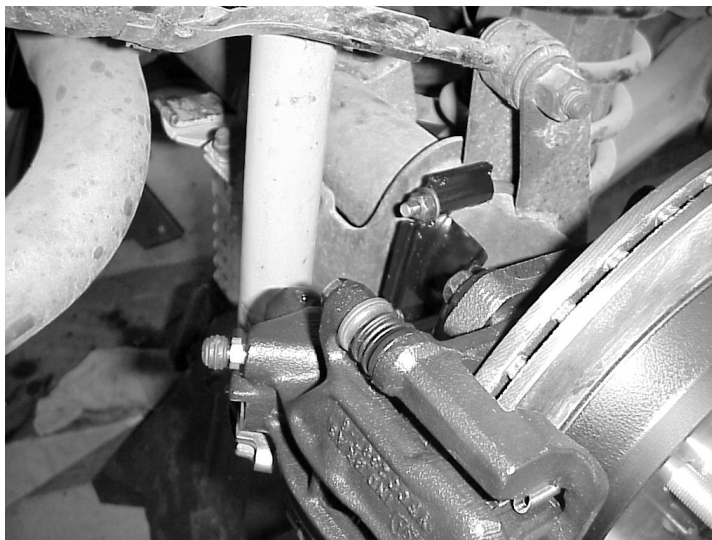

Factory Ford shop manuals are available from Helm Publications, 1-800-782-4356



M-2300-M Mustang GT Rear Disc Brake Bracket Kit INSTALLATION INSTRUCTIONS

NO PART OF THIS DOCUMENT MAY BE REPRODUCED WITHOUT PRIOR AGREEMENT AND WRITTEN PERMISSION OF FORD RACING PERFORMANCE PARTS.

- STEP 29:** Attach the hose ends to the calipers with the sealing rings installed on the banjo bolts as shown. Torque banjo bolts to 30-40 ft./lbs.

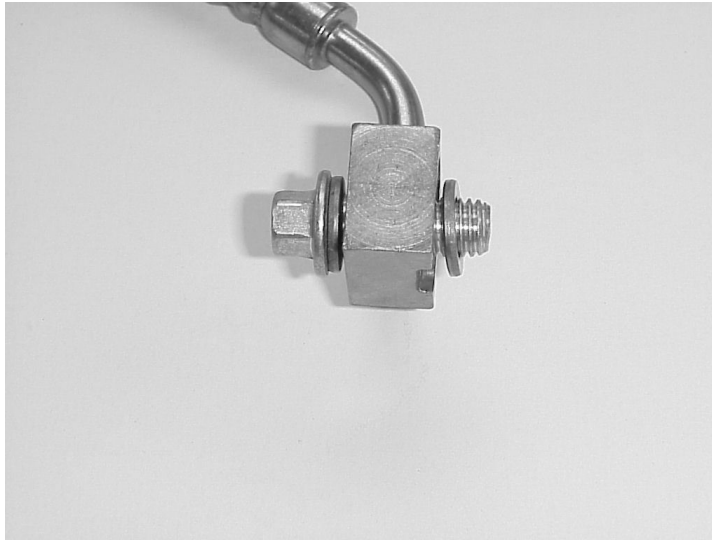

- STEP 30:** Secure parking brake cables to calipers as shown.



Factory Ford shop manuals are available from Helm Publications, 1-800-782-4356



M-2300-M Mustang GT Rear Disc Brake Bracket Kit INSTALLATION INSTRUCTIONS

NO PART OF THIS DOCUMENT MAY BE REPRODUCED WITHOUT PRIOR AGREEMENT AND WRITTEN PERMISSION OF FORD RACING PERFORMANCE PARTS.

STEP 31: Recheck all fittings to ensure all connections are tight.

STEP 32: Fill the master cylinder with new DOT 3 or DOT 4 (recommended) brake fluid and keep it full during the brake bleeding process.

!!! Caution: Brake fluid contains polyglycol ethers and polyglycols. Avoid contact with eyes. Wash hands thoroughly after handling. If brake fluid contacts eyes, flush eyes with running water for 15 minutes. Get medical attention if irritation persists. If taken internally, drink water and induce vomiting. Get medical attention immediately. !!!

STEP 33: Bleed the brake system manually or with a power bleeder (recommended) in the following sequence:

- Right rear
- Left rear
- Right front
- Left front.

Continue bleeding the brake system in this sequence until all air is removed from the system and a firm brake pedal is obtained.

Note: The rear calipers may trap air. Tap them lightly while bleeding the rear brakes.

- STEP 34:** After bleeding is completed, inspect all connections in the front and rear system for leaks and repair as required.
- STEP 35:** Reinstall the wheel and tire assemblies. Torque bolts to 85-105 ft./lbs.
- STEP 36:** Remove jack stands and safely lower the vehicle to the ground.
- STEP 37:** Find a safe place to check your brake system for proper operation.

Factory Ford shop manuals are available from Helm Publications, 1-800-782-4356