



Supercharger Installation Manual

Ford Mustang GT 4.6L 24 Valve

Engine: Ford 4.6L 24 Valve
Mustang Model Years: 2005-2010

CALIFORNIA AIR RESOURCE BOARD EXECUTIVE ORDER #D-231-30

Table of Contents

Introduction	3
Kit Components	3
Supercharger Oil.....	3
Recommended Tools	3
Pre-Installation Checklist	4
Supercharger Installation Instructions	5
Illustrated Installation Guide.....	6
Maintenance and Service	90
Maintenance.....	90
Servicing Your Supercharger.....	92
Post-Installation Checklist	93
Checklist Review.....	93

Symbol Key

Throughout this installation guide you will see the following symbols used:

↻ NOTE

Used to indicate tips and information to aid in installation, maintenance, or use of the supercharger.

!! CAUTION !!

Used to indicate precautions that must be taken to avoid damage to the supercharger and associated components.

⚠ WARNING!!

Used to indicate precautions that must be taken to avoid bodily injury as well as damage to the supercharger and associated components.

Introduction

This supercharger was created for the 4.6L Ford 24 valve engine, model years of 2005-2007. It has been designed and tested specifically for this application. Before beginning installation of this supercharger, first **read this section carefully** then complete the **Pre-Installation Checklist**.

Kit Components

Before beginning installation, be sure you have identified all components of your Whipple FRPP Supercharger Kit. Check the supplied packing slip.

Supercharger Oil

As described in the **Illustrated Installation Guide**, the supercharger must be filled with oil prior to use. This supercharger is shipped without any oil inside. The oil is in a separate bottle supplied with your kit and you will be instructed to add it in the **Illustrated Installation Guide**.



Warning label attached to Supercharger housing

!! CAUTION !!

Do not attempt to start the engine before adding the supplied Supercharger Oil to the supercharger!

Recommended Tools and Supplies

The following items are not included in this supercharger kit and it is strongly recommended that they're used for ease of installation or maximum performance:

Fuel Line Removal Tool

You will need to remove the factory fuel line and fuel rail, this requires a special tool, contact your local parts store or Ford parts dealer.

Torque Wrench

You will need a quality torque wrench to ensure proper tightening of bolts.

Tie Straps

These will be useful for securing the wiring harness away from the installation area as directed in the **Illustrated Installation Guide**. They are inexpensive and will be very handy during installation.

Sealants

Blue Loctite™ #242 or equivalent, Red Loctite™ #271 or equivalent. All bolts that need Loctite™ are marked with:

 **Loctite™ (#242 blue) threads** and  **Loctite™ (#271 red) threads**. Thread sealant such as pipe Teflon must be used on all pipe threads.

Chemicals and lubricants

You will need some cleaner/degreaser such as carb cleaner.

You'll be required to fill your intercooler system with approx. 1 gallon of distilled water and Ford approved engine coolant. This is not supplied in the system, you can find the coolant at any local auto parts store.

Motor oil will be useful as a lubricant and should be readily available during installation.

Vacuum

A vacuum is necessary to clean up any debris resulting from grinder use.

Clean Shop Towels

Use these to keep the installation area clean.

Pre-Installation Checklist

Before installing your Whipple Ford Racing Supercharger Kit, complete the following checklist.

!! CAUTION !!

Failure to complete the Pre-Installation Checklist may result in severe engine damage after installation is complete.

1. Verify Condition of Vehicle: Before the supercharger kit is installed, ensure the engine runs smoothly and that the factory malfunction indicator light (MIL) is off. Only install the supercharger kit if the engine runs smoothly *and* the MIL is off.

!! CAUTION !!

This product is intended for use only on stock, unmodified, well-maintained engines. Installation on a worn-out or modified engine is not recommended without factory computer and fuel system modifications.

2. Verify Fuel Octane: Ensure fuel of 91-octane or higher is in the vehicle fuel tank. If the octane grade is not known, drain the fuel tank completely and fill to 1/8th with fuel of 91-octane or higher.

!! CAUTION !!

Use only 91 octane fuel or higher. If fuel of less than 91-octane is present in the vehicle fuel tank, the tank must be completely drained and refilled with 91 or higher octane to 1/8th of a tank.

3. (INTERCOOLED/HIGH OUTPUT) Verify that your fuel level is below a ¼ full. When changing the fuel pump, this will be very important. If fuel level is above a 1/4 tank, then you will be required to drain fuel until you reach a ¼ tank or less.
4. Assess Cleanliness of Installation Area: Make sure your work area and the underhood area are free from debris. This supercharger is a high-quality, close-tolerance compressor and must not be subjected to contamination by dirt or any type of foreign material.

!! CAUTION !!

DO NOT remove the protective seal on the supercharger prior to installation. Foreign material entering the supercharger will automatically void all warranties.

5. Identify Supercharger Kit Components: Before beginning installation, identify all the components of your Whipple Supercharger Kit and ensure all items are present and undamaged.
6. Read Illustrated Installation Guide: Be sure to read through the **Illustrated Installation Guide** starting on page 6 *before* beginning supercharger installation. Familiarize yourself with the components and tools you will use and the procedures before you start for faster and easier installation.

Supercharger Installation Instructions

Vehicle: 05-07 Mustang
Engine: 4.6L 24V

Before you begin installing the Whipple Ford Racing 4.6L 24V Supercharger, make sure you have completed the **Pre-Installation Checklist**. Be sure you have:

1. Verified the Condition of the Vehicle
2. Verified the Fuel Octane
3. Verified that the fuel level is below a ¼ tank.
4. Assessed the Cleanliness of the Installation Area
5. Identified the Supercharger Kit Components
6. Read and Understood the Illustrated Installation Guide
- Have you completed all items in the **Pre-Installation Checklist**?

➤ NOTE

****NOTICE:** Installation of Whipple Supercharger products signifies that you have read this document and have agreed to the terms stated within.

It's the purchaser's responsibility to follow all installation instruction guidelines and safety procedures supplied with the product as it's received by the purchaser to determine the compatibility of the product with the vehicle or the device the purchaser intends to install the product on.

Whipple Superchargers assumes no responsibility for damages occurring from accident, misuse, abuse, improper installation, improper operation, lack of reasonable care or all previously stated reasons resulting from incompatibility with other manufacturer's products.

There are no warranties expressed or implied for engine failure or damage to the vehicle in any way, loss of use or inconvenience or labor reimbursement. This includes merchantability and fitness.

⊘ NEVER SMOKE DURING THE INSTALLATION OF THE SC, THERE WILL BE FLAMMABLE FUMES AND LIQUID AROUND THE VEHICLE

Be sure you have read and understand the **Introduction** section and have completed the **Pre-Installation Checklist**, then proceed to the **Illustrated Installation Guide**.

Illustrated Installation Guide

It is strongly recommended that you read through this guide before you begin installing the Whipple Supercharger.

1. Using an air hose, blow off any loose dirt or debris from engine compartment. If really dirty, then steam clean the engine compartment before proceeding to the next step.
2. Release fuel system pressure.



- The fuel pump relay can be found in the bussed electrical center located on the passenger side, front of engine compartment fuse panel. The fuel pump relay is located in position 21 as shown in the inside cover of the bussed electrical center. Remove the fuel pump relay.
- Start the engine and allow it to idle until it stalls.
- After the engine stalls, crank the engine for approximately 5 seconds to make sure the fuel injection supply manifold pressure has been released.
- Turn the ignition switch to the OFF position.

⚠ WARNING!! Batteries normally produce explosive gases. Therefore, do not allow flames, sparks or lighted substances to come near the battery. When charging or working near a battery, always shield your face and protect your eyes. Always provide ventilation. Failure to follow these instructions may result in personal injury.

⚠ WARNING!! Keep out of the reach of children. Batteries contain sulfuric acid. Avoid contact with skin, eyes or clothing. Also, shield your eyes when working near the battery to protect against possible splashing of the acid solution. In case of acid contact with the skin or eyes, flush immediately with water for a minimum of 15 minutes and get prompt medical attention. If acid is swallowed, call a physician immediately. Failure to follow these instructions may result in personal injury.

3. Disconnect ground cable from battery using an 8mm wrench.
4. HOOD LINER: Under highway driving, the hood liner will push down towards the SC pulley, this will put a cut in the hood liner. It's recommended that you remove the hood liner. Remove the factory plastic clips and the hood liner will come off.
5. Find the factory coolant drain spigot located on the passenger side of the factory radiator (use a 19mm socket). Drain coolant in a coolant container, store for later use. ****You may be able to use a 5/16" ID hose to route the coolant away from the frame rail for a cleaner drain.**

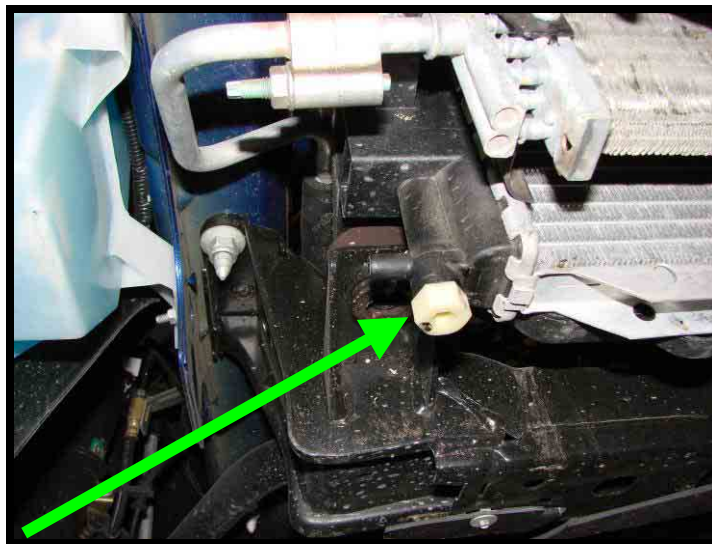

6. Disconnect the following factory electrical connectors:

- Mass Air Flow Sensor element. Carefully pull red tab out, squeeze the connector and then pull the connector away from connection.



- Electric Fuel PSI sender. Squeeze connector and pull.

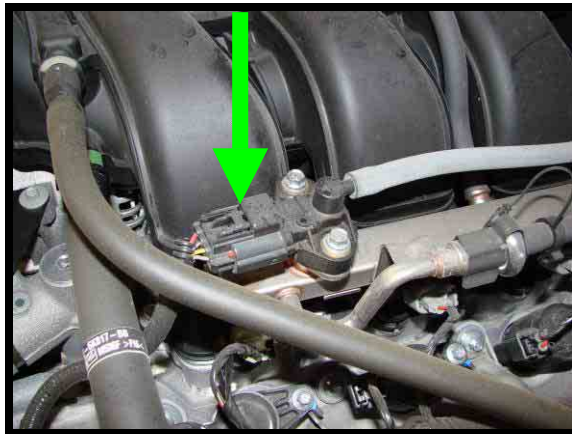

- Electronic Throttle Control motor. Carefully pull red tab out, squeeze the connector and then pull the connector away from connection.

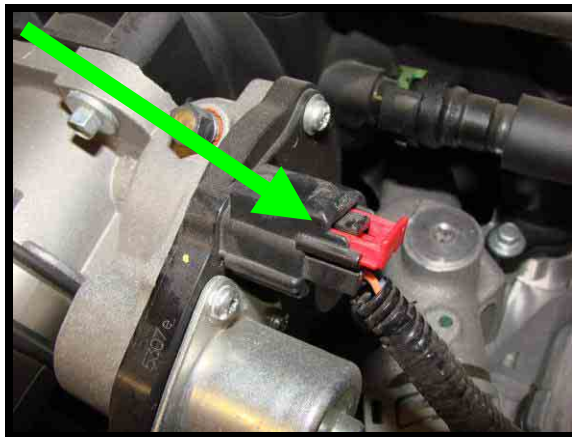

- Throttle Position Sensor. Carefully pull red tab out, squeeze the connector and then pull the connector away from connection.

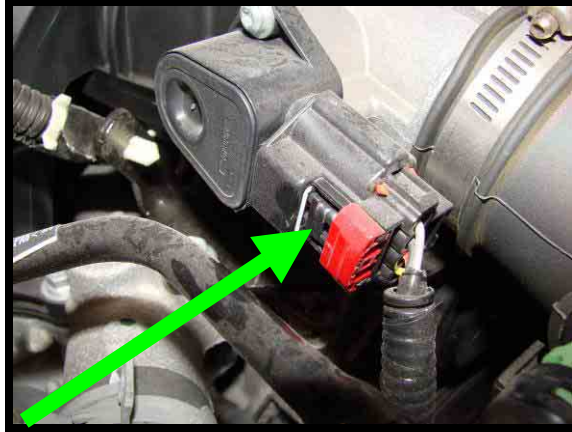

- Charge Motion Control motor (located on rear/passenger side of engine). Push down tab and pull connector away.



7. Disconnect plastic breather hose from passenger side valve cover to rubber inlet piece. To release, push green tab on bottom side and then pull.

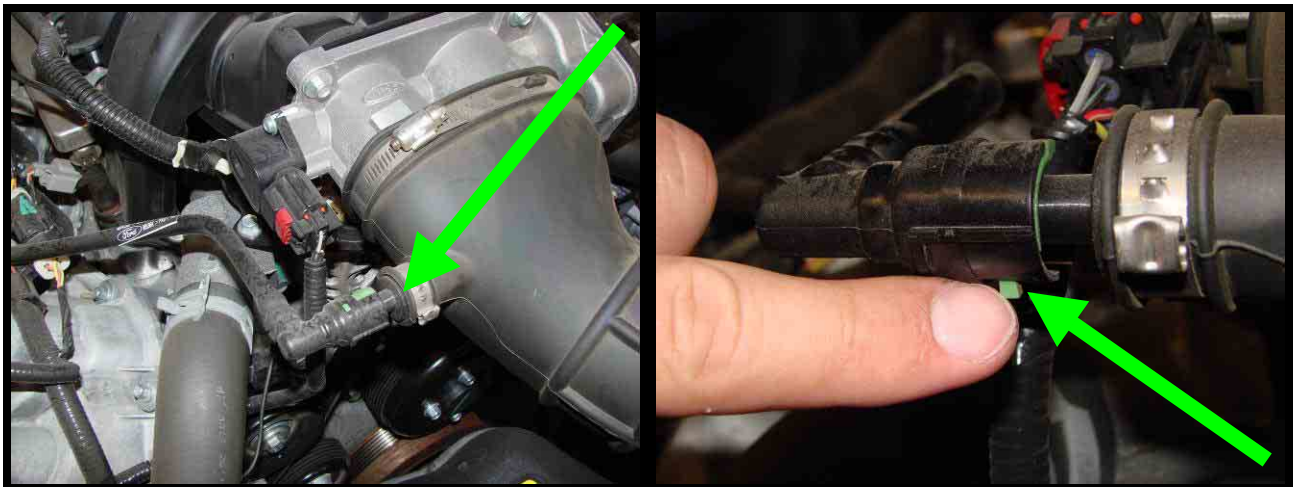

8. Disconnect plastic EVAP connector (coming for purge solenoid) from factory intake manifold. To release, squeeze the clear plastic portion of the connector and pull.

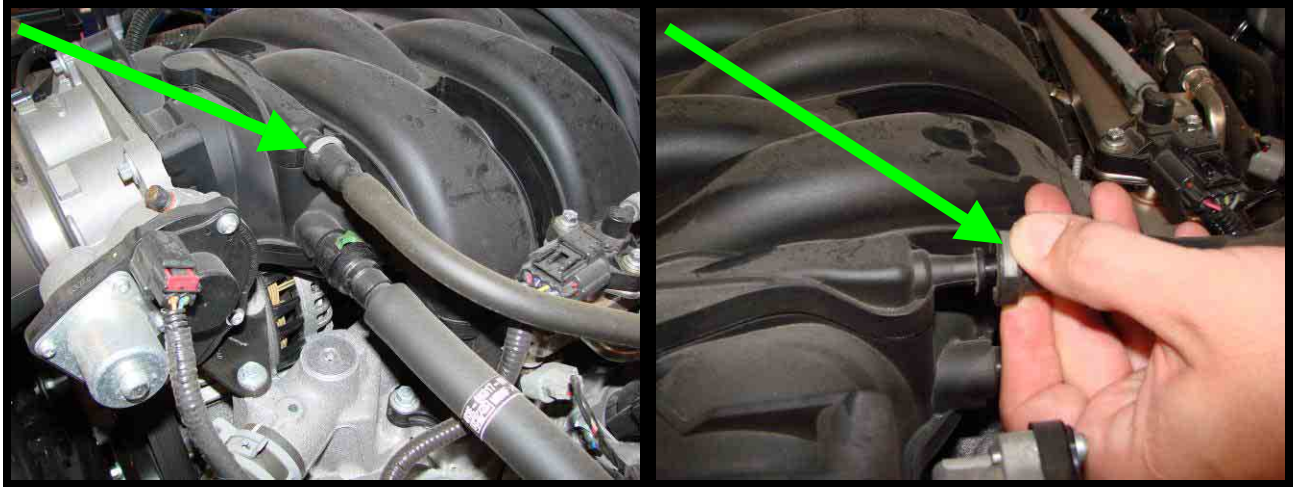

9. Disconnect plastic PCV hose fitting from driver side valve cover. To release, push green tab on bottom side and then pull.



10. Disconnect plastic PCV hose fitting from driver side of intake manifold. To release, push green tab on bottom side and then pull.

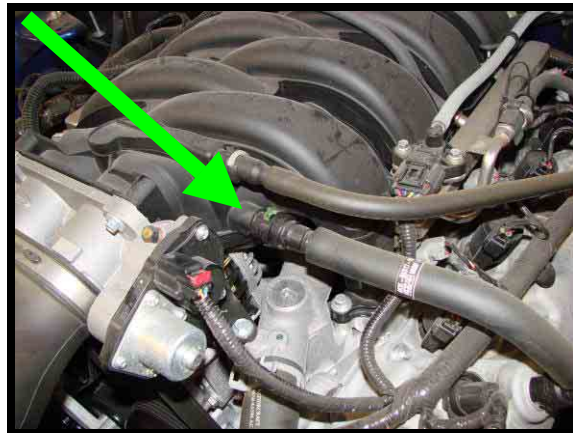

11. Remove 3/8" ID rubber vacuum hose from brake booster barbed fitting.



12. Remove the (1) 6mm bolt securing the factory air box (10mm socket) and loosen the hose clamp securing the rubber inlet hose to throttle body. Remove air box and rubber inlet hose.
13. Disconnect fuel injector connectors by squeezing connector and pulling.
14. Disconnect coil connectors by squeezing connector and pulling.
15. Remove plastic radiator shroud cover by removing the (6) plastic retaining clips.
16. Remove radiator to overflow tank rubber hose from overflow tank. Push hose away for now.

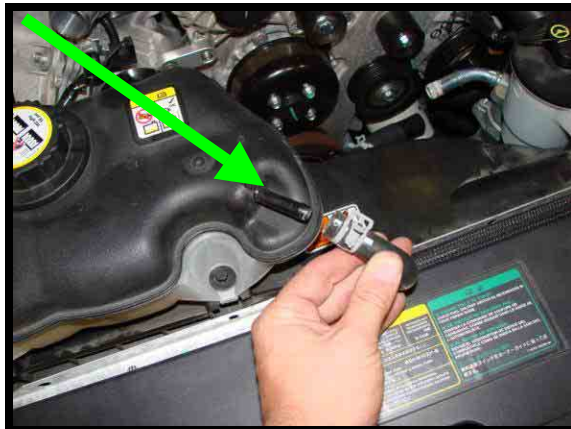

17. Move your coolant container under the factory thermostat housing, remove thermostat housing to overflow tank rubber hose at thermostat housing. (Drain coolant from system).



18. Remove the (2) 6mm bolts securing overflow tank (8mm socket). Remove overflow tank from vehicle. **Save for later use.**



19. Remove the thermostat housing to water cross over rubber hose (Motorcraft #4R3E-8A594-AC) from the water cross over by removing the factory pinch clamp.

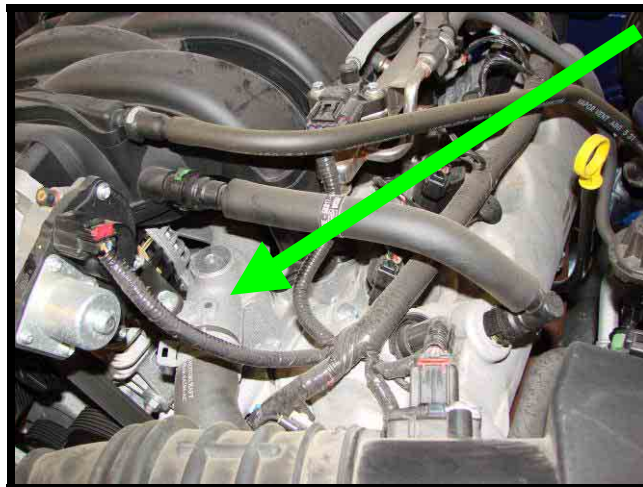

20. Remove the water cross over to radiator rubber hose from the water cross over by removing the factory pinch clamp.



21. Remove steel coolant hose support bracket by removing the (1) 8mm nut (13mm socket).

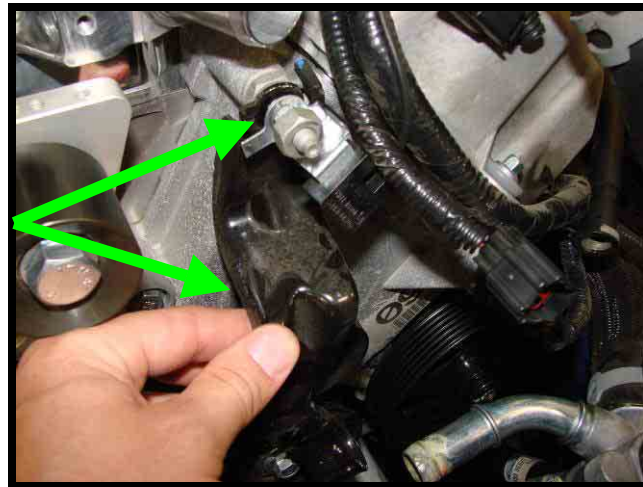

22. Remove the (8) ignition coils from engine. Remove the (8) mounting bolts (7mm socket). Pull coil packs up and out. **Save for later use.**
23. Remove the (8) spark plugs from engine (9/16 spark plug socket).
24. **(NON-INTERCOOLED)** Install the new supplied 0 range spark plugs (9/16" spark plug socket) and torque to 25 ft/lbs.
25. **(INTERCOOLED 05-2008)** Install the new Ford Racing spark plugs M-12405-3V0 that are specifically gapped to **.032"** (9/16" spark plug socket) and torque to 25 ft/lbs.
- NOTE!** Cars built after 05/27/08 May have a new style plug regap stock plugs to .032 or call Whipple **(INTERCOOLED 2009-2010)** Use new Ford Racing spark plugs M-12405-3V12mm that are gapped to .032
- Reinstall the (8) ignition coils and (8) 6mm mounting bolts (7mm socket), torque to 53 in/lbs.
26. Reconnect the (8) ignition coil electrical connectors, push until they click and lock in place.

27. Disconnect the factory fuel line safety clip from factory fuel line. Remove the factory fuel line using a fuel line removal tool. **Safety clip will be used later.**

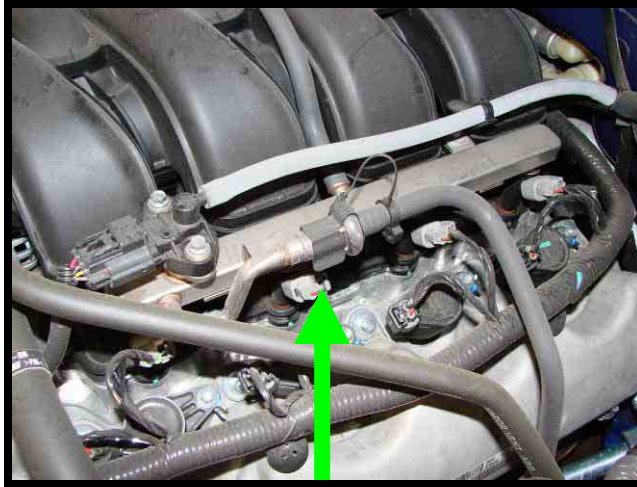

28. Remove the rubber vacuum line from the fuel PSI sender. **Save for later use.**

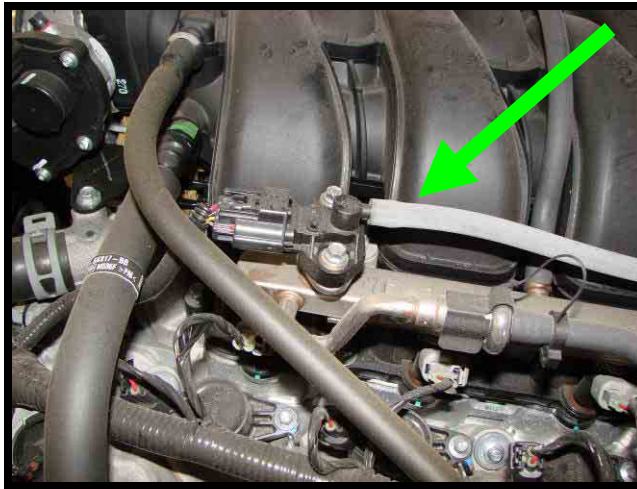

29. Remove the plastic retainer securing the wiring harness to the intake manifold.
30. Remove fuel rail from intake manifold by removing the (4) 6mm mounting bolts (8mm socket) and pulling rail up and away. **Save for later use.**
31. Remove the factory intake manifold from engine by removing the (10) 6mm bolts (10mm socket) and pulling up and away.
32. Remove the factory throttle body from intake manifold by removing the (2) 6mm bolts (8mm socket) and (2) 6mm nuts (10mm socket).
33. Remove factory throttle body oring from intake manifold. **Save for later use.**
34. Remove the (2) 6mm throttle body mounting studs from intake manifold. This can be done with a stud removal tool as well as installing (2) nuts and locking them together. **Save for later use.**
35. Clean the cylinder head surface and install duct tape to head surface to protect engine.

36. Remove metal clips securing fuel injectors to fuel rail by pulling fasteners apart and down. **Save for later use.**

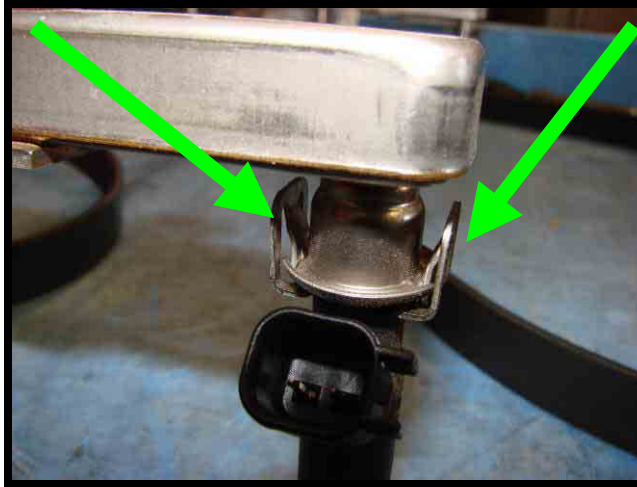

37. Remove the alternator support bracket by removing the (4) 6mm fasteners (8mm socket and 10mm socket).

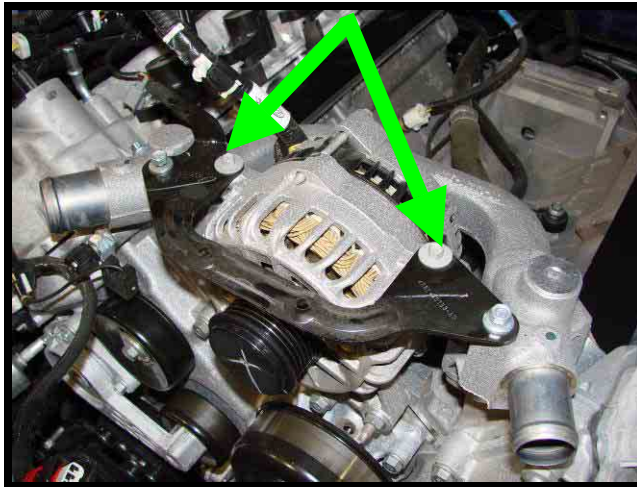

38. Remove the (2) 8mm nuts (13mm socket) securing the alternator to the engine block. Place alternator to the side of the engine. **Save (1) for later use.**

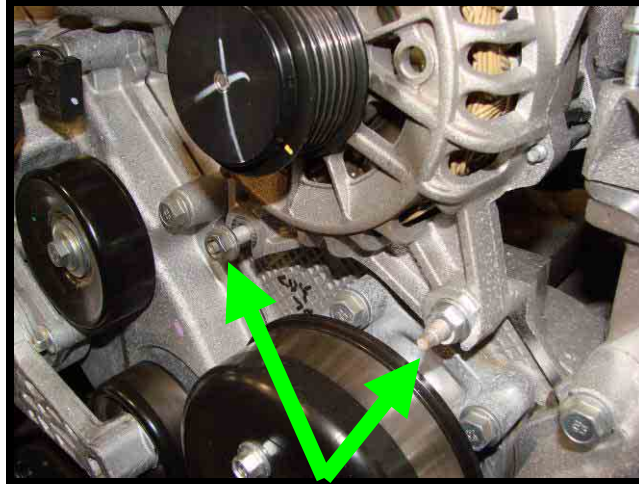

39. Remove the driver side alternator mounting stud (1) (5mm socket).

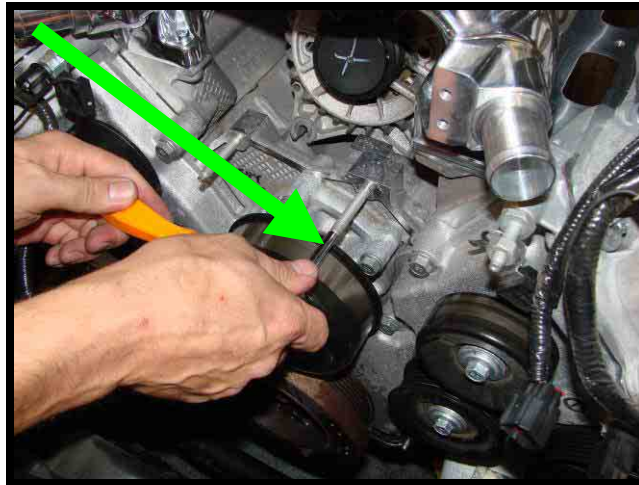

40. Remove the heater hoses plastic connector from water cross over by squeezing clear plastic portion of connector and pulling back and away.

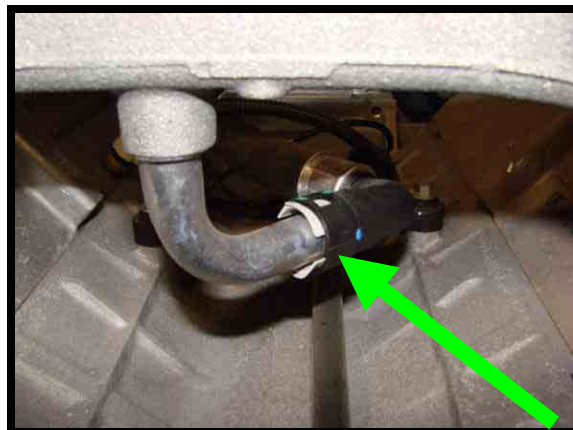

41. Remove the water cross over by removing the (4) 6mm bolts (10mm socket) and pulling out of the way.
42. Clean engine block to water cross over mounting surface and install duct tape to protect engine.

43. Disconnect the cylinder head temp sensor connector from sensor. Squeeze connector and pull away for the time being.



44. Remove the electrical connectors (2) from the rear metal bracket that secures the heater hoses by pushing the plastic retaining tangs from the bracket.

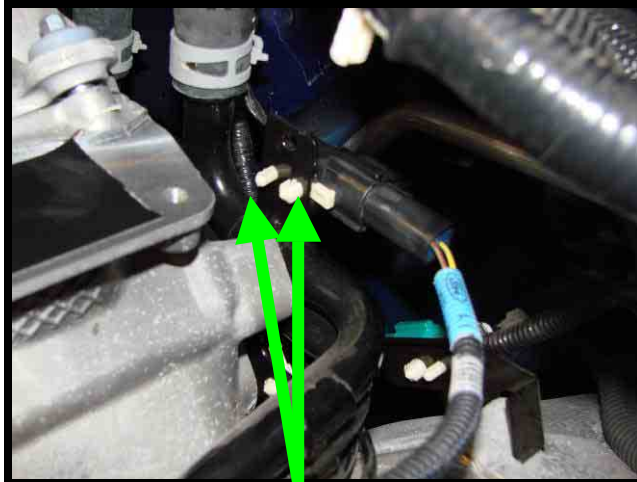

45. Remove the metal bracket (secures hard water lines) from the back of the passenger side cylinder head by removing the (1) 8mm bolt (13mm wrench).

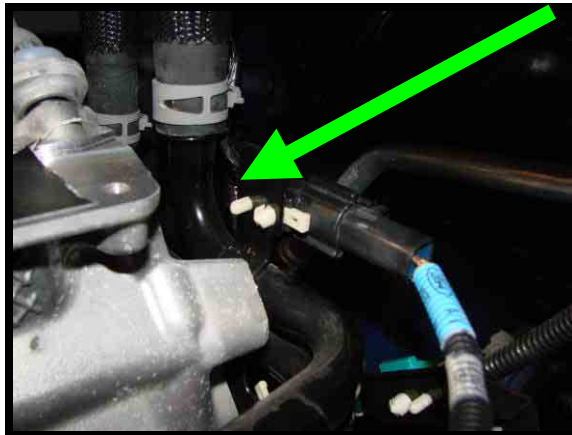

46. Disconnect the (2) heater hoses from the metal bracket/hard line and pull hard line away from block.

47. Place the top heater hose over the factory engine harness and towards the center of the engine.



48. Remove the (2) factory orings from heater hose bung coming from engine block.



49. Reposition the knock sensor wires by loosening the (2) 8mm bolts (10mm socket). Position the wires so they face the cylinder head and back of the engine. Torque to 15 ft/lbs.

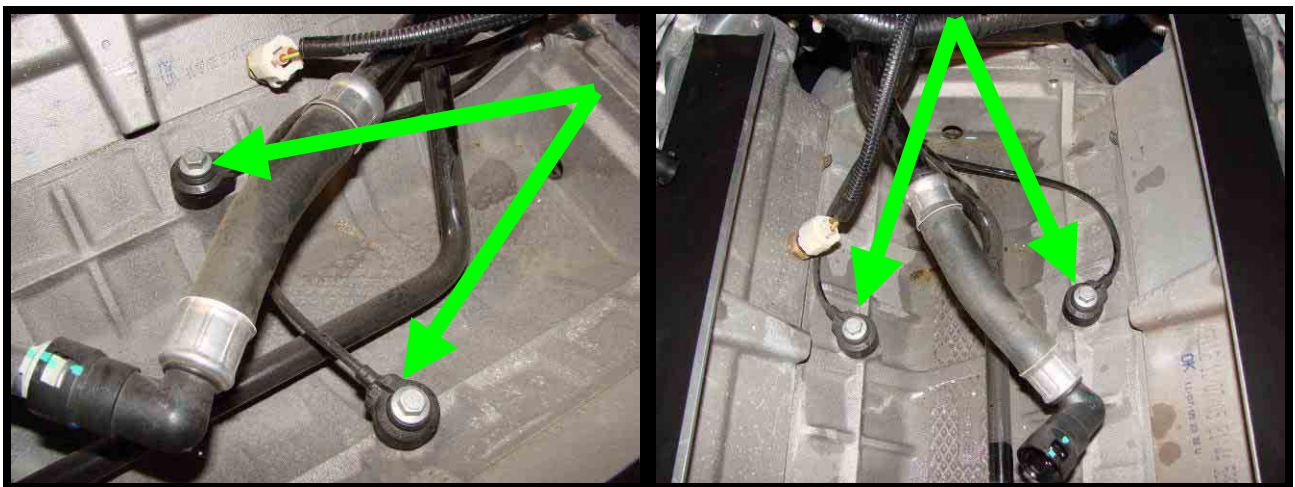

50. Secure factory charge motion control electrical connector to engine harness with zip-tie.

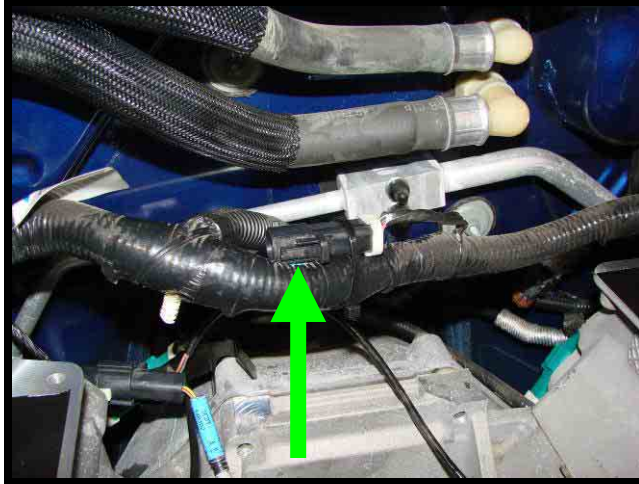

51. Reconnect the cylinder head temperature connector to sensor.
52. Tuck away cylinder head temp connection to back/passenger side of engine.



53. Install the supplied heater hose (PN# 46301940) to factory heater hose bung and tighten hose clamp (5/16" nut driver).



54. Connect the supplied heater hose (PN# 46301940) and barb fitting to top heater hose you previously routed over engine harness. Secure with pinch clamps.

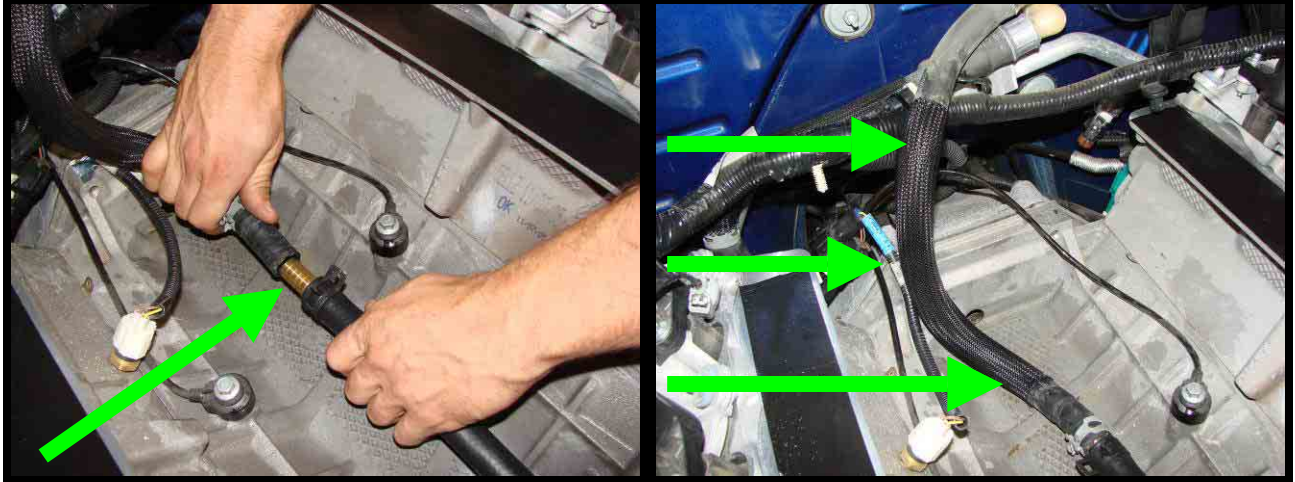

55. Slide the heater hose sheathing up so it's approx. 3" away from the barb and pinch clamps.
56. Pull the thermostat housing apart by removing the (2) 6mm bolts (8mm socket). Remove the factory thermostat.

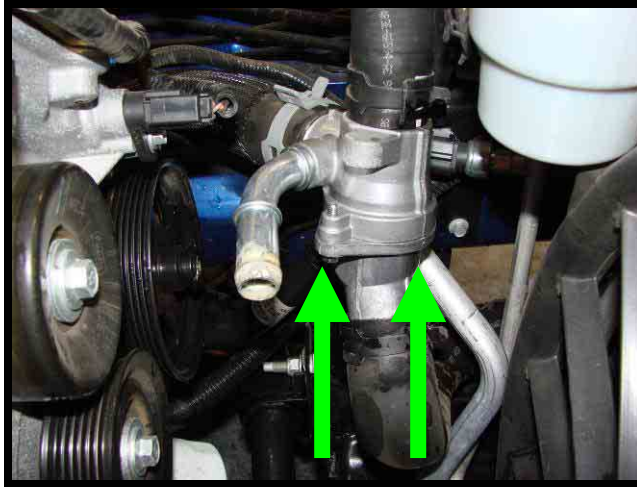

57. (05-06) Install the new supplied 160deg F thermostat just as factory unit, bottom side of stat faces up and factory oring rest against the thermostat (SEE FOLLWING FIGURE), reinstall the (2) factory 6mm bolts (8mm socket) and torque to 110 in/lbs.

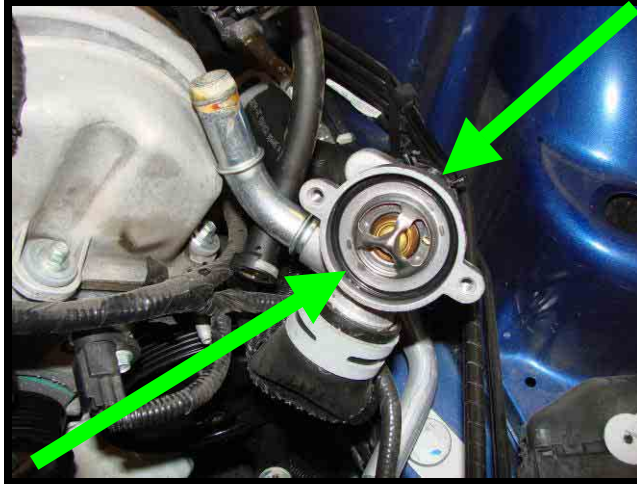

58. (2007-2010 Models) Install thermostat to new cross-over assembly. Install factory oring on top of thermostat.

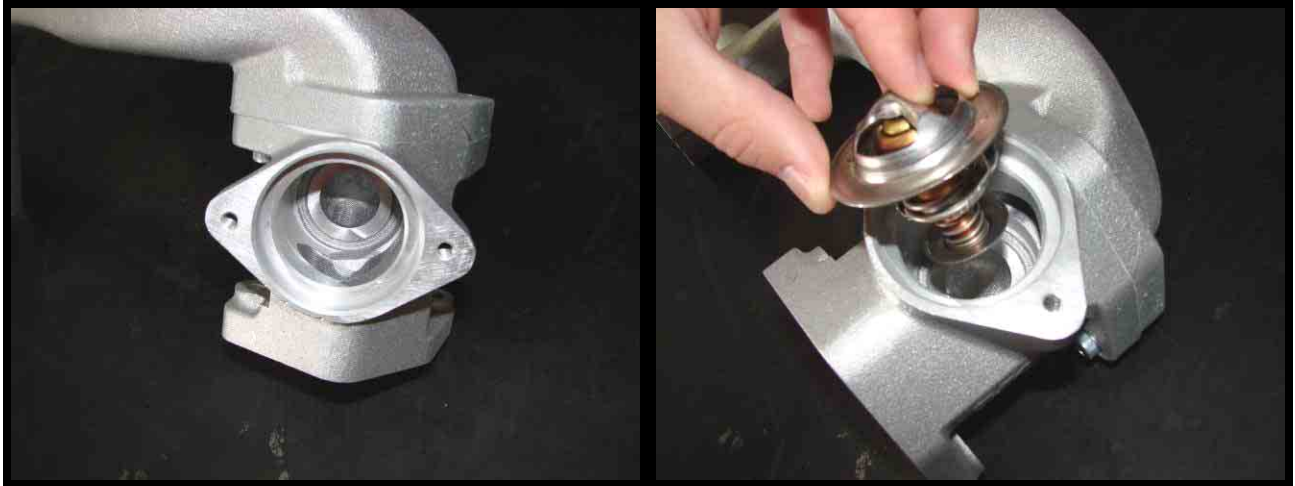

59. Install the supplied water neck fitting #F5RZ-8K528-CC to cross over, utilize the factory 6mm hardware to secure.



60. Remove the factory orings from water cross over.



61. (05-06) Install round factory water cross over oring to new supplied water cross over.



62. (05-06) Install factory water cross over oring to the supplied billet water cross over spacer plate. 07+ models does not require the spacer, factory oring needs to be installed into supplied cross-over assembly.



63. **(05-06)** (07+ models skip this step) Install supplied oring to water cross over, first apply light amount of grease or silicone to hold in place. Install oring into groove. Make sure the oring installs evenly and has no bumps that can pinch during installation.

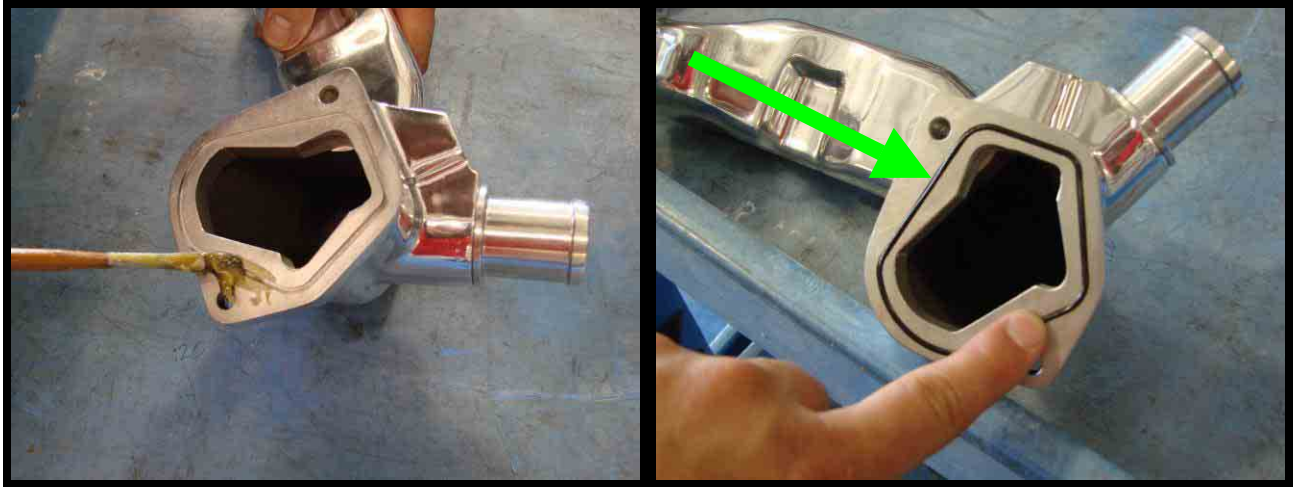

64. Put alternator in center valley of the engine block.

65. **(05-06)** (07+ models skip) Install billet cross over spacer, oring side down to the engine block, align holes.



66. **(05-06 only)** Install the supplied water cross over. Secure with the supplied (1) 6mm x 35mm (5mm allen socket) and (1) 6mm x 55mm (5mm ball-head allen socket or 5mm wrench). Snug bolts but **DO NOT TIGHTEN AT THIS TIME.**

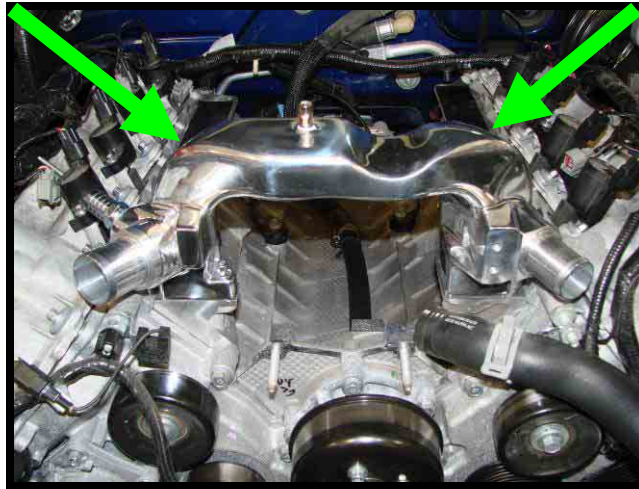

67. (2007+ models only) Install supplied water cross over. Secure with the supplied (1) 6mm x 35mm (5mm allen socket) and (1) 6mm x 45mm (5mm ball-head allen socket or 5mm wrench). The idler support bracket will be secured by the 6mm x 45mm bolt which secures it to the cross over. Snug bolts but **DO NOT TIGHTEN AT THIS TIME.**

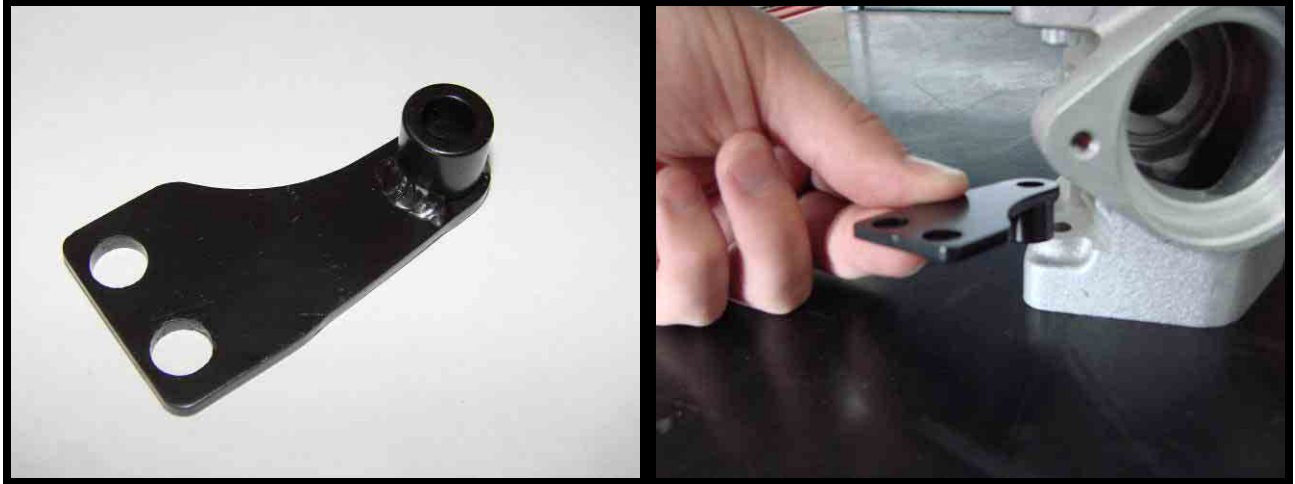

68. Pull the alternator through the water cross over and set on the factory passenger side stud. Make sure the alternator clears the cross over. If there is interference, use a file to remove some material from the alternator. Be sure that the motor is protected from any metal shavings.
69. Remove the passenger side factory steel idler pulley from block by removing the (1) 8mm bolt (13mm socket). **INTERCOOLED VERSIONS**, remove the driver side factory steel smooth idler pulley.

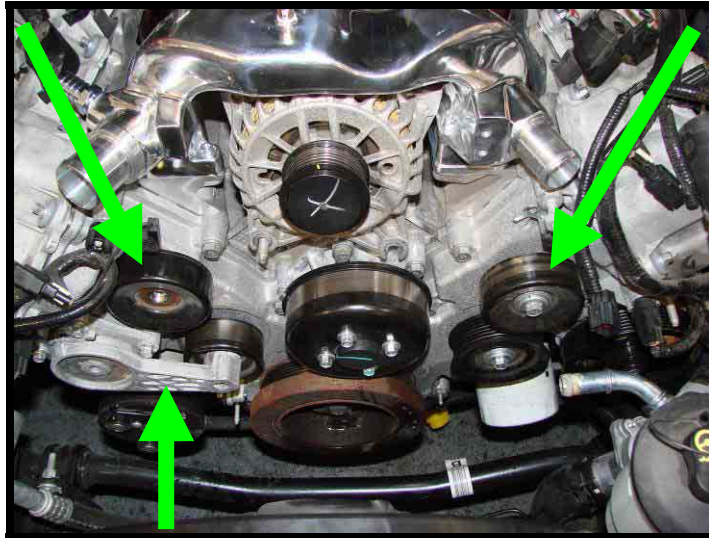

70. Remove the factory timing chain cover (2) 8mm bolts to block (13mm socket).

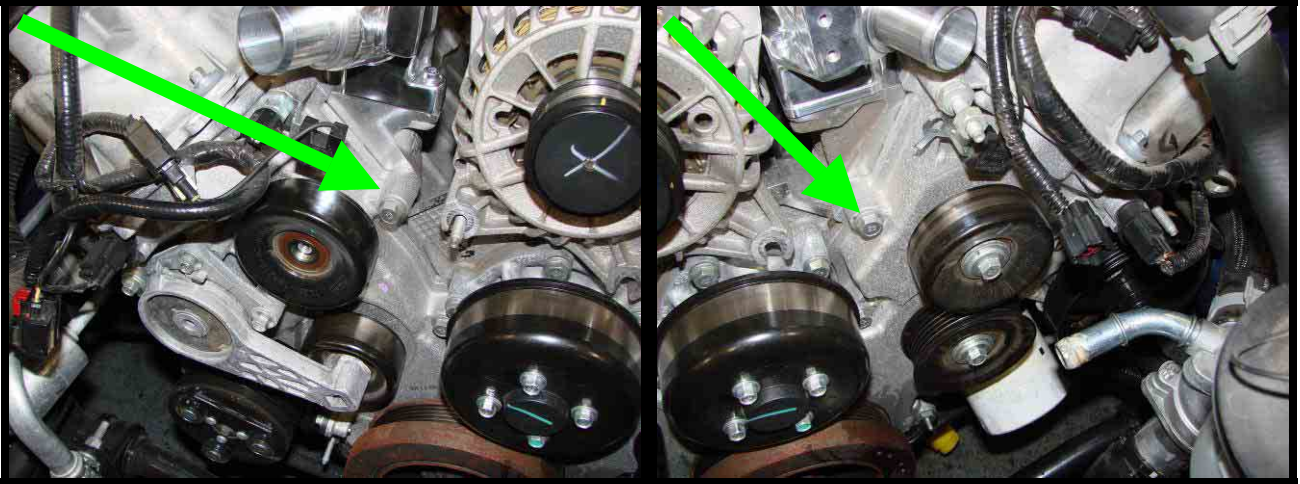

71. Install the supplied alternator support brace over the passenger side alternator stud with the thicker side against the alternator. Secure in place by reinstalling the factory 8mm timing chain 8mm bolt and the factory alternator 8mm nut (1). DO NOT TIGHTEN AT THIS TIME.

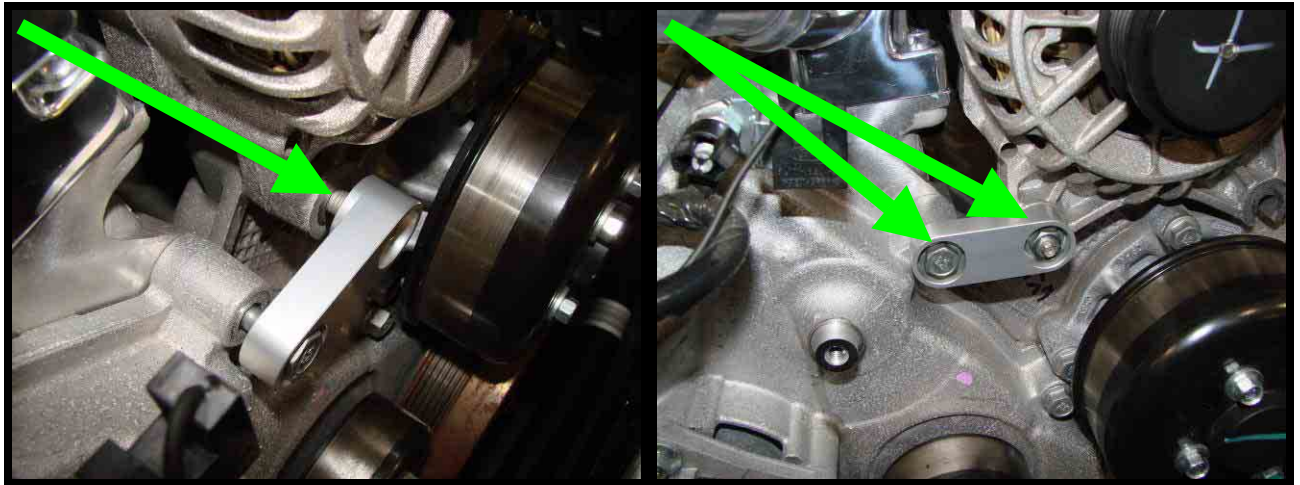

72. Install the supplied sliding idler assembly to engine block by using the supplied (1) 8mm x 60mm hex head bolt with (1) 8mm AN washer through the bracket and alternator, then use the factory timing chain cover bolt to secure the other side of the sliding idler assembly. This bracket sandwiches the driver side leg of the alternator.

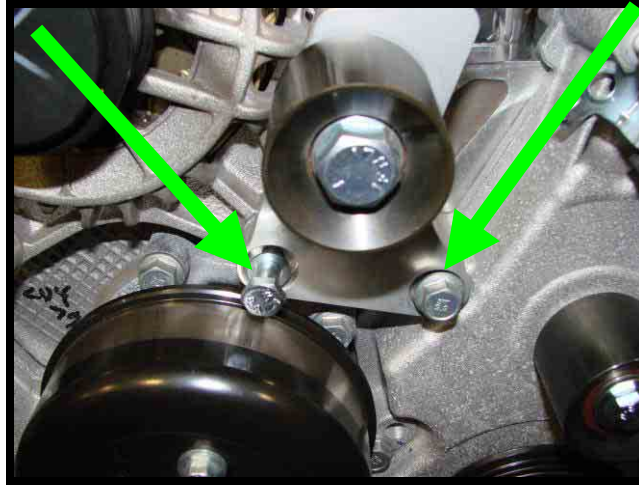

73. Torque the sliding idler assemblies inner (1) hex head bolt (through alternator) (13mm socket) to 25 ft/lbs.



74. Torque the sliding idler assemblies outer (1) hex head bolt (through timing chain cover) (13mm socket) to 37 ft/lbs. Follow by going another 90degrees.

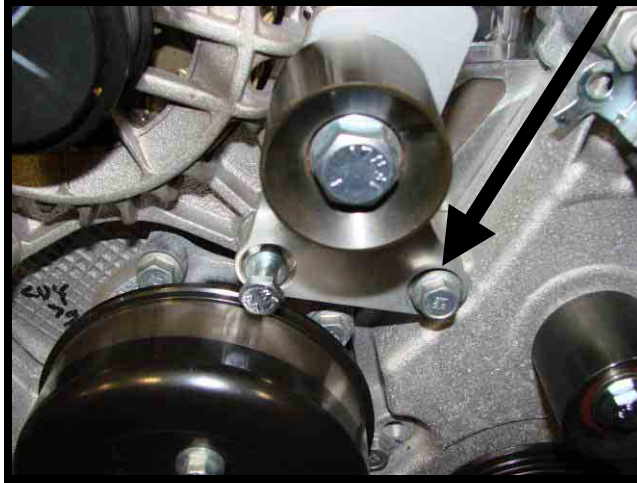

75. Torque the passenger side alternator support bracket inner mounting (1) nut (13mm socket) to 25 ft/lbs.

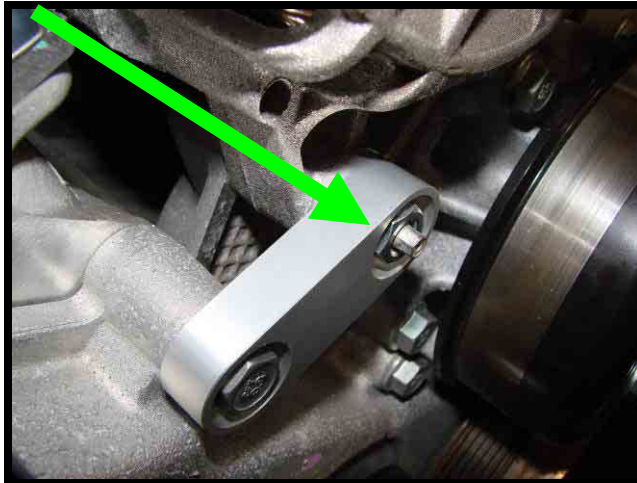

76. Torque the passenger side alternator support bracket outer mounting (1) hex head bolt (13mm socket) to 37 ft/lbs. Follow by tightening 90degrees.



77. Install the supplied steel sliding idler support bracket by using the supplied (4) 6mm x 12mm button head allen bolts (5mm allen socket) (**07+ models only utilize (2) 6mm x 12mm bolts**). Apply light amount of pipe thread sealant to the upper (2) button head allen bolt threads. Torque to 89 in/lbs.



78. Remove the spring loaded tensioner by removing the (3) 8mm bolts (10mm socket).

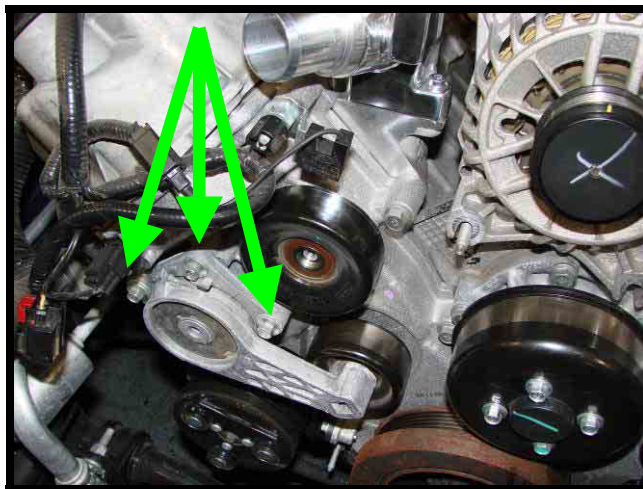

79. Grind the tensioner stop from the spring loaded tensioner. Clean tensioner and reinstall to engine block using the factory (3) 8mm bolts (10mm socket). Torque to 18 ft/lbs.



80. (HO kits, pulley size 3.625" 3.5", 3.375", 3.250") Remove the factory pulley from the spring loaded tensioner. Install 100mm idler pulley. Torque to 25 ft/lbs.



81. Remove the supercharger assembly from the intake manifold by removing the (10) 8mm x 20mm 6-point bolts (10mm socket and wrench) and lifting up and away.

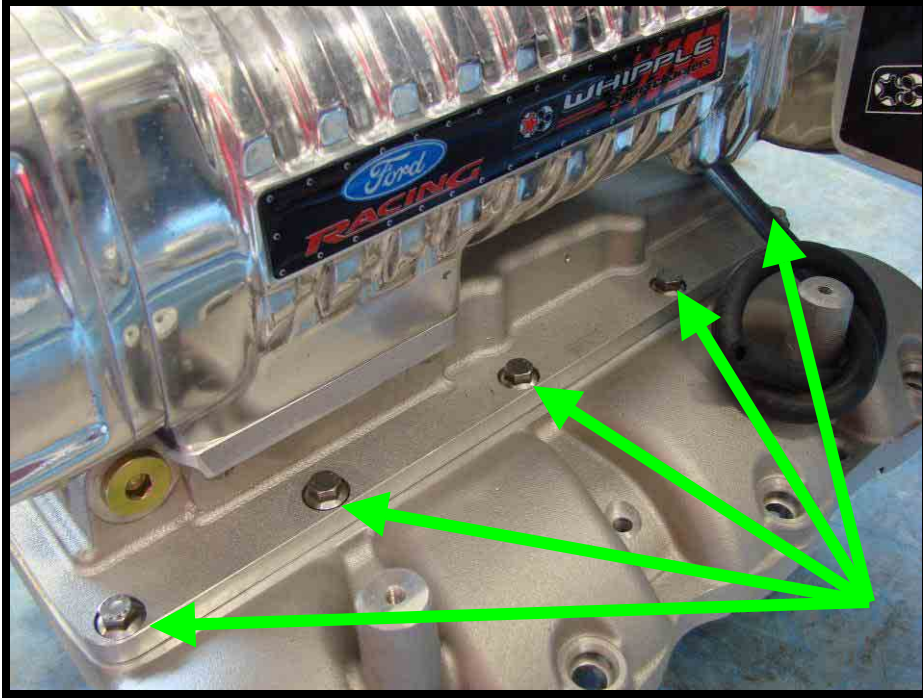

82. Install the factory fuel psi sender rubber hose you removed earlier to the rear 90deg 7/32" barbed fitting. Secure hose with zip tie.



83. Remove factory orings from factory intake manifold. (NOTE! Cars built from 05/27/08 on have different factory gasket please use orings provided in kit)

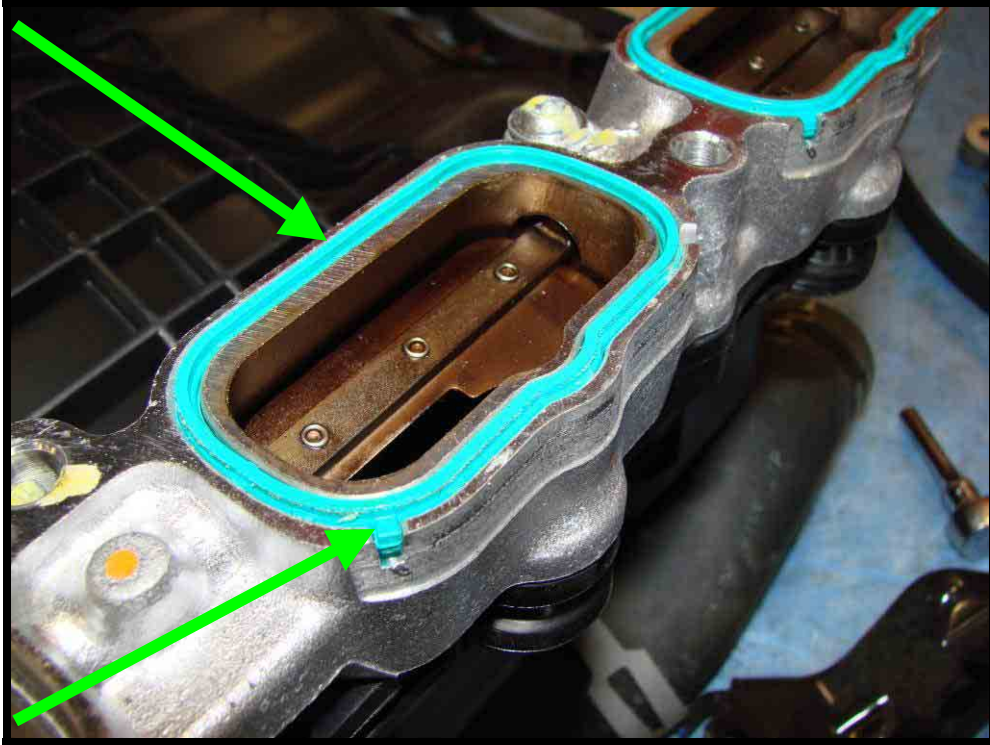

84. Install factory manifold orings into new intake manifold. (NOTE! Cars built from 05/27/08 on have different factory gasket please use orings provided in kit)

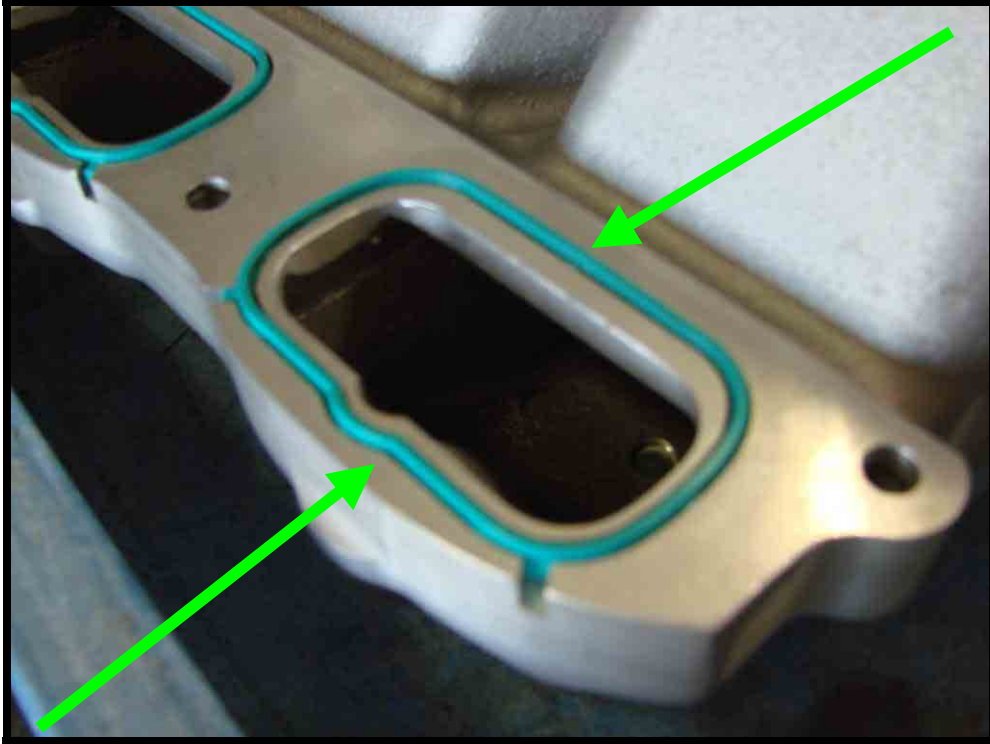

85. Place the new intake manifold on engine. Secure in place with the supplied (6) 6mm x 35mm and (4) 6mm x 45mm socket head allen bolts (5mm allen socket). Make two torque passes (from center and out), first pass should be torqued to 89 in/lbs. Second pass, torque to 125 in/lbs.
86. Torque the water cross over (4) 6mm socket head allen bolts (5mm ball head allen socket) to 125 in/lbs.
87. Apply light amount of pipe thread sealant to the supplied billet 5/8" OD quick connect fitting and install in the lower, front pipe port.



88. Apply light amount of pipe thread sealant to the supplied billet 3/8" OD quick connect fitting and install in the top pipe port.



89. Apply light amount of pipe thread sealant to the supplied billet 3/8" barb fitting and install in the bottom back pipe port.



90. Apply a couple of strips of duct tape to the firewall to protect the paint when you install the SC system.
91. Apply light amount of gasket cinch to intake manifold to supercharger assembly flange.

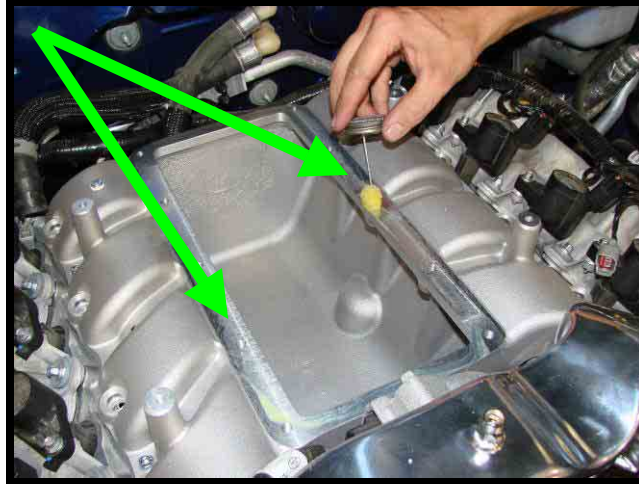

92. Carefully install the supplied intake manifold to supercharger assembly gasket to flange, line it up with bolt holes before the gasket cinch dries.
93. Install supercharger assembly to intake manifold. Use the supplied (10) 8mm x 20mm 6-point bolts (10mm socket and wrench). Torque to 20 ft/lbs.

94. Install injector locking clips to new supplied fuel injectors.



95. Apply light amount of engine oil to new fuel injector orings. Install new supplied fuel injectors to factory fuel rails, electrical connectors must face out.



96. Install the passenger side factory fuel rail with new fuel injectors, secure fuel rail using the factory (2) 6mm bolts (8mm socket). Torque to 115 in/lbs.
97. Install the supplied fuel line (PN# 46301950) to the driver side fuel rail barbed fitting. Secure hose with supplied hose clamp (7mm nut driver).



98. Install driver side fuel rail to engine, route rubber fuel line (PN# 46301950) over the supercharger and. Secure fuel rail using the factory (2) 6mm bolts (8mm socket). Torque to 89 in/lbs.
99. Install supplied fuel line (PN# 46301950) to passenger side fuel rail barbed fitting. Secure with clamp (7mm nut driver).
100. Plug in the fuel injector electrical connectors to the new fuel injectors.
101. Reconnect the fuel PSI sender electrical connector.

102. 2008-2010 fuel psi sender relocation The air intake system for the 2008 and 2009 Mustang supercharger kit requires the fuel pressure transducer to be remote mounted This will allow the air intake system to be positioned correctly for hood clearance

Once you have re-installed the factory fuel rails, you can now install the fuel pressure transducer remote mounting parts. Start by removing the factory fuel pressure transducer from the stock fuel rail, using an 8mm wrench or socket. While removing, be careful not to damage the sealing o-ring on the transducer. The factory bolts will be used again so make sure you do not lose them.



103. 2008-2010 Once the transducer is removed, install the low profile end of the remote mount to the fuel rail. This is the end that has the o-ring on it. Make sure you lubricate the o-ring before you attempt to install it to the fuel rail or you may damage the o-ring. Fasten this end of the remote mount using the (2) M5 x 12mm socket head cap screws provided. Tighten the SHCS.

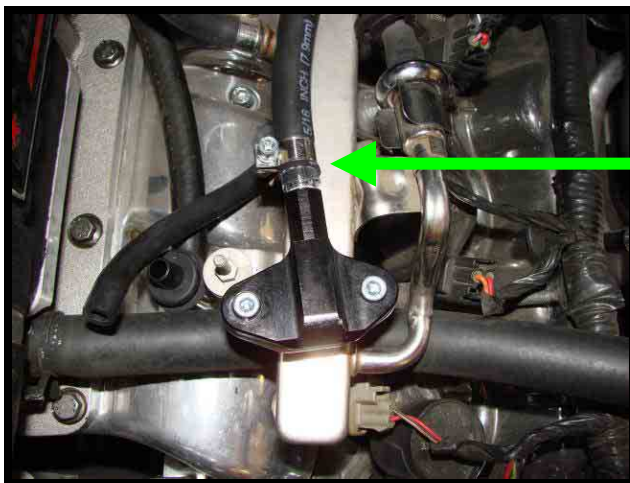

Make sure clamp is oriented correctly if its on top move to the side so it wont hit air tube

104. 2008-2010 The factory fuel pressure transducer will now be installed to the other end of the remote mount the same way it was in the factory fuel rail. Make sure to lubricate the o-ring before attempting to install it into the remote mount. Failure to do so may damage the sealing o-ring. Fasten the transducer to the remote mount using the factory bolts.



105. 2008-2010 Re-connect the electrical plug to the transducer.



106. 2008-2010 Connect the 1/4" rubber hose that is coming from the 90 deg fitting on the discharge to the hose barb on the transducer. The remote mount will rest next to the fuel fitting inlet and the dip stick.

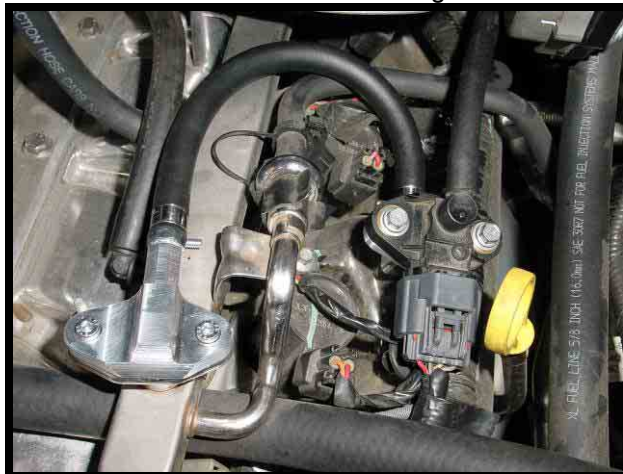

107. Install wiring harness retaining clips to factory fuel rail retaining bolts.

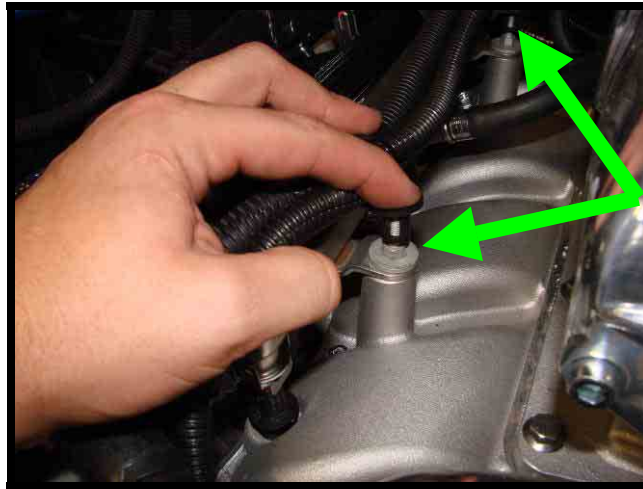

108. Route the factory 7/32" rubber fuel pressure sender line from the rear 90deg barbed fitting (out of supercharger adapter) to the fuel psi sender barb. Secure hose with zip tie.
109. Install the supplied heater hose (PN# 46301945) the bottom heater hose coming from the firewall. Secure hose with pinch clamps.
110. Install the supplied heater hose (PN# 46301945) to the 3/4" barbed fitting on the water cross over, trim this hose to fit so it runs flush with the fuel rail. Secure with pinch clamp.

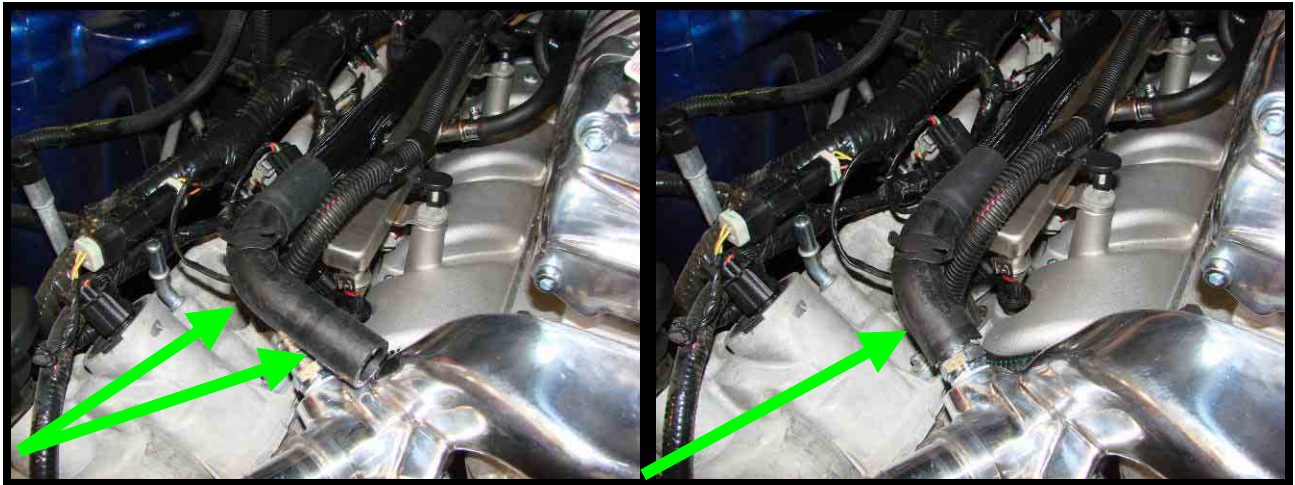

111. Reinstall factory fuel line to the factory fuel fitting. Press until you feel it lock in place. Reinstall the fuel line safety clip.
112. Install the factory throttle body oring to supercharger inlet to throttle body mounting flange.

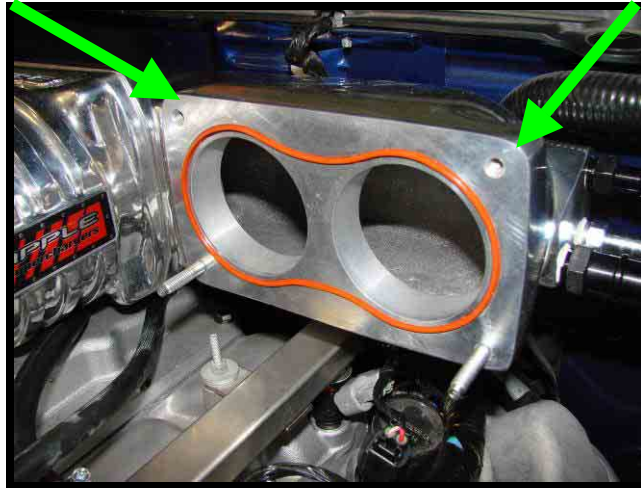

113. Install the (2) 6mm throttle body mounting studs to the two lower throttle body mounting holes.



114. Install the factory throttle body to the supercharger intake. Secure with the factory fasteners, (2) 6mm nuts on the bottom (10mm socket) and the (2) 6mm bolts on the top (8mm socket). Torque to 89 in/lbs.



115. Install the supplied 6-rib belt. With the spring loaded tensioner in its max open position, adjust the sliding idler down as far as possible. Torque this bolt to 35 ft/lbs. (3/4" socket) and then release the spring loaded tensioner.

BELT ROUTING (3.75" – 4.0" SC PULLEY)

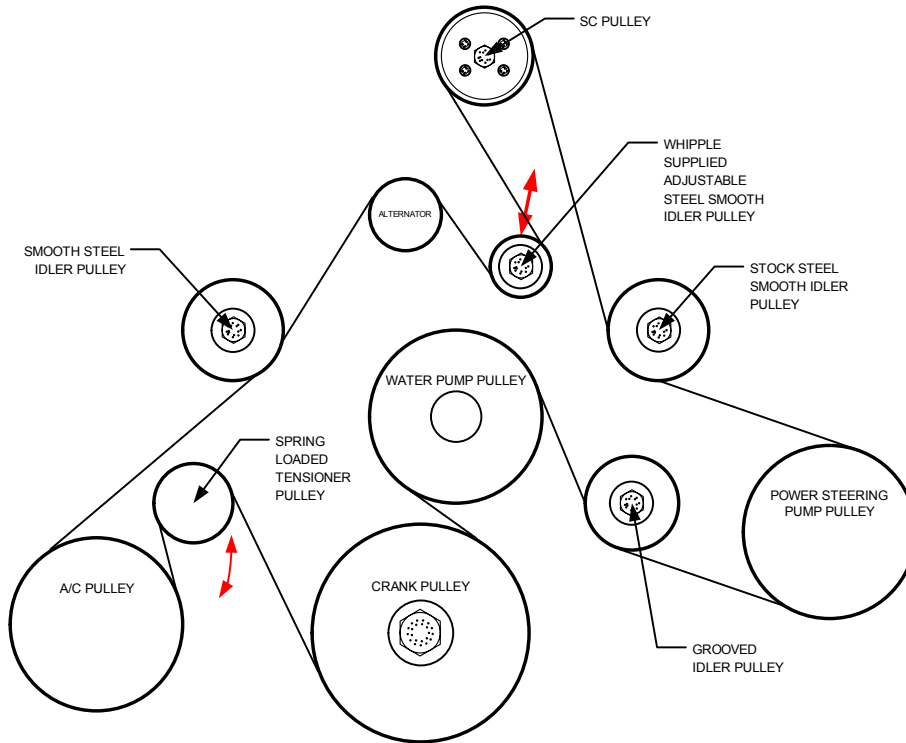

BELT ROUTING (3.5" – 3.625" SC PULLEY)

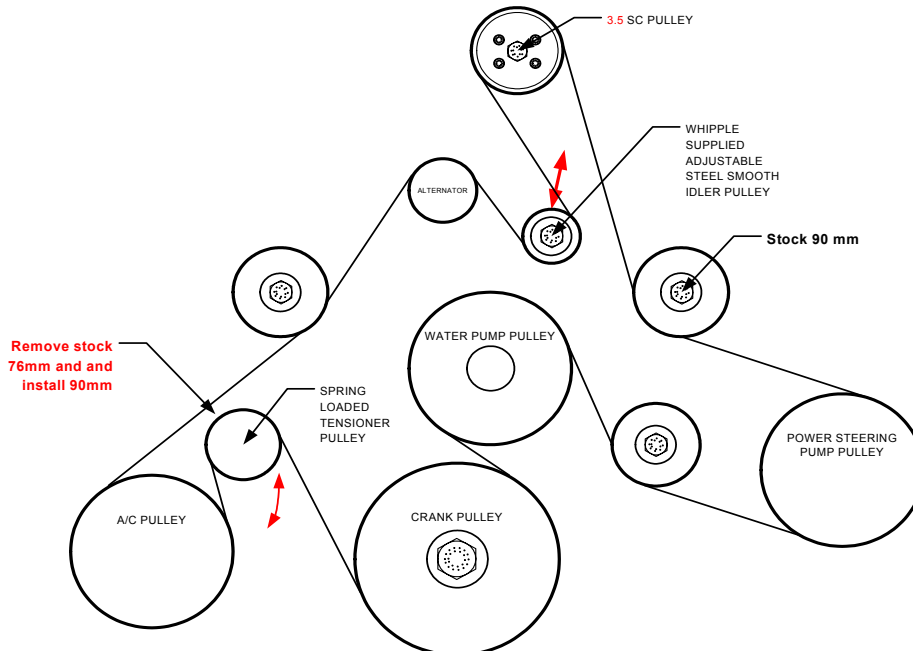

BELT ROUTING (3.125" – 3.375" SC PULLEY)

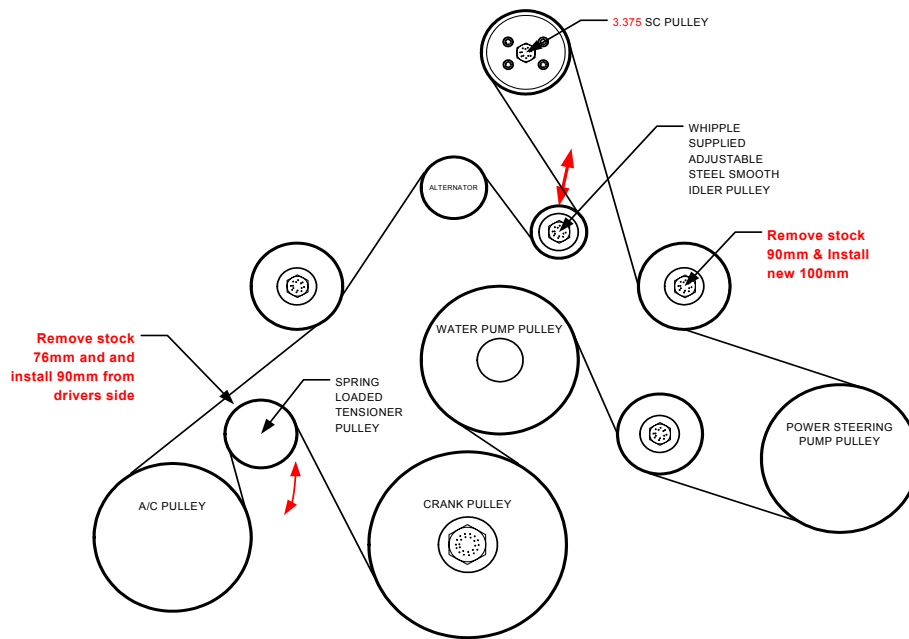

116. Locate the factory PCV plastic hose. Using a razor, cut the plastic 90deg quick connect fitting from plastic hose and remove fitting.



117. Using a razor blade, cut the factory shielding off the PCV hose. Do not damage the plastic tubing.
118. Cut the plastic PCV tubing right after the barb of the straight fitting.



119. Cut the plastic PCV tubing directly after the barb of the PCV tube where the 90deg fitting was located.



120. Clean PCV tube so no plastic debris is left around in or on the outside of the tube.
121. Locate the supplied PCV rubber hose #46301960. Insert the plastic PCV tube into the supplied rubber hose, push this until it's centered into the rubber hose. The end with the slight bend should go to the SC inlet side.
122. Install the factory 90deg plastic quick connect fitting into one side of the PCV hose, secure with supplied pinch clamp.
123. Install the supplied 90deg plastic quick connect fitting into the other side of the PCV hose, secure with the supplied pinch clamp.
124. Route the factory EVAP hose and install onto the 3/8" OD quick connect fitting located in the supercharger inlet housing. Push fitting until it clicks in place.

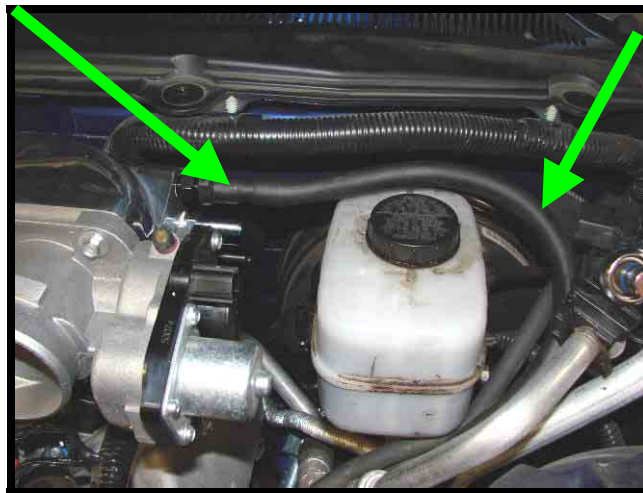

125. Install the supplied 3/8" rubber hose (PN# 46301955) and install on the brake booster barb fitting and route to the 3/8" OD barbed fitting located in the supercharger inlet housing. This hose may need to be trimmed to fit. **VERIFY THAT THERE ARE NO KINKS IN THIS LINE!!**



126. Install the modified PCV hose (#46301960) to the billet 1/2" OD fitting in the supercharger inlet housing. Push fitting on until it clicks in place. NOTE: The plastic tube that was inserted into this hose should have the bend towards the SC inlet.



127. Route other end of PCV line (hose #46301960) with 90deg quick connect fitting to the PCV barbed fitting coming from the driver side valve cover. Press until you hear it snap in place.

128. **(2005-2007 INTERCOOLED/HIGH OUTPUT 2008-2009 see page 49) INTERCOOLER SYSTEM**

INSTALLATION . Route the water pump to IC reservoir hose (PN#46301930) with the straight end going underneath the ABS brake system and over to the driver side of the frame rail.



129. Install the 90deg rubber hose with 3/4" union to straight end. The 90deg should face towards the center of the vehicle. Install supplied pinch clamp 4" from end of hose for later installation.



130. (05-06 only) Install the supplied (6) 8mm coupling nuts to the factory front support bolts, torque to 130 in/lbs.



131. (2007+ models only) Install the supplied (2) 8mm coupling nuts to the outer-most driver-side factory support bolts. Torque to 130 in/lbs.

132. (05-07) Remove the factory (1) 6mm bolt from the fender using a 10mm socket.



133. Install IC reservoir mounting bracket tang into the factory hole in strut tower. Install other side of bracket to fender, secure with the factory (1) 6mm bolt using a 10mm socket.



134. Install the supplied pinch clamp 4" from end of hose on the 90deg bend of the 3/4" hose (IC reservoir to pump hose). Apply light amount of engine oil or silicone spray to inner wall of hose, slide over nipple of IC reservoir. Secure with pinch clamp.



135. Install IC reservoir to bracket by installing the flat steel plate to top of plastic reservoir mounting holes. Install the supplied (2) 6mm x 25mm hex head flanged bolt. Torque to 100 in/lbs.



136. Route the IC fitting to IC reservoir hose (#46301920) to driver side IC fitting by sliding through the #2 cylinder injector and first driver side injector rail mounting boss. Install pinch clamp on end of hose, push hose onto fitting, secure end with pinch clamp.



137. Install the IC fitting to the IC reservoir hose (#46301920) to IC reservoir top nipple. Install pinch clamp on end of hose, push hose onto fitting, secure end with pinch clamp.



138. Install the supplied (1) pinch clamp to the IC feed hose (PN#46301925), approximately 3" from end of 90deg end. Install this end to the passenger side IC fitting. Secure with pinch clamp.



139. Route the IC feed hose (PN#46301925) down the passenger side cylinder head then over to the passenger side of the frame rail.

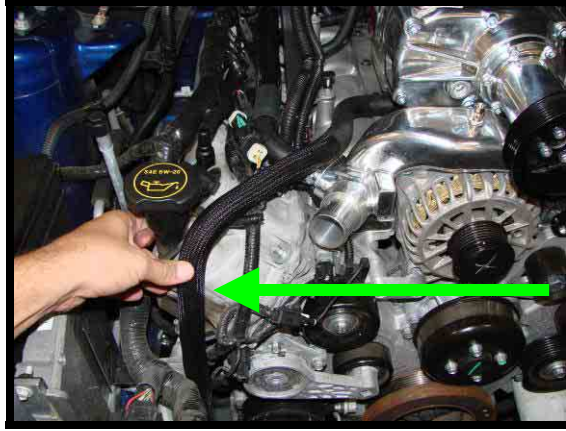

140.

2008-2010 ic reservoir

141. In order to use the new and improved lower air box on the 2008 thru 2010 Mustang, a new intercooler reservoir (tank) and tank location must be used. The following instructions will show you what is needed to be done to mount the reservoir and route the intercooler hoses.
142. (08-10) The new tank will be mounted to the top of the fan shroud on the driver's side next to the power steering reservoir. Place the new tank on the fan shroud. The bottom contour of the new tank will fit the contour of the fan shroud to aid in proper location.



Transfer the location of the two holes in the tank onto the fan shroud. Drill the two holes (use a 1/4" drill) in the fan shroud that you transferred from the tank location.

143. (08-10) To ease the installation of the new tank, unbolt the fan shroud and move the shroud away from the radiator. You could remove the entire fan shroud from the car, but this is not necessary. As long as you are able to reach the underside of the shroud to secure the tank.



144. (08-10) Secure the tank to the shroud using the provided hardware. (2-M6 x 25 FHSCS and 2-M6 flange nuts).



This completes the mounting of the tank.

145. (08-10) The water pump hose assembly (#46301930-tank to pump) will remain the same, but will be routed different using the new tank.
146. (08-10) Instead of routing the hose under the brake control unit, it will be routed in front of it and up to the tank. Secured by a constant tension hose clamp.



147. (08-10) The intercooler return hose assembly (#46302920-I/C to tank) will be the new hose used in this application. This hose will be routed from the top hose barb on the tank, to the driver's side hose barb threaded into the discharge casting.



Secure the hose with the two provided constant tension hose clamps. The larger of the two goes on the hose at the tank.

148. (2010) The power steering reservoir will need to be relocated to the fan shroud as it was on earlier models. This will allow the new air box to be positioned properly.
149. (2010) Unbolt the power steering reservoir from the mount located in front of the driver's side valve cover. Remove the mount also.



150. (2010) Turn the p/s reservoir around, making sure not to kink any of the lines, and secure it to the fan shroud. There should be a tab on the bottom off the reservoir that will slip into a slot on the fan shroud. There should also be an existing factory j-nut located on the fan shroud.



151. (2010) In order for the new air box to fit properly, the wire loom located above the driver's side headlight must be repositioned. To do so, carefully unclip the loom from the sheet metal. The loom should have enough slack in it for repositioning.

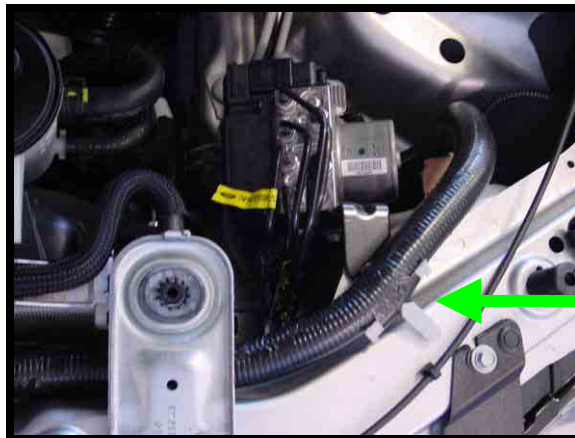

152. (2010) You will need to route the wire loom behind and under the brake control unit so it is out of the way of the new air box.



153. (2005-2009 heat exchanger & water pump) Set the heat exchanger on a clean bench, facing backwards (drivers seat view). The 3/4" OD fitting should face top left. The 5/8" OD fitting should face bottom right.

Note 2010 heat exchanger see page 57



154. Install the supplied (4) rubber grommets to heat exchanger mounting holes.



155. Install the supplied (4) billet bushings into the rubber grommets. The large end will be facing your current top view.



156. Apply light amount of  **Loctite™ (#271 red)** to threads of the supplied (4) 8mm x 35mm flat head bolts.

Install these into the bushing and steel support brackets. Torque to 130 in/lbs.



157. Assemble the electric water pump assembly. Mount billet pump collar to steel mounting bracket by utilizing the supplied (2) 8mm x 25mm hex head flanged bolts. Torque to 130 in/lbs.



158. (05-06 only) Install the heat exchanger to the (4) 8mm coupling nuts you installed previously. Apply light amount of  **Loctite™ (#271 red)** to threads of the supplied (4) 8mm x 16mm hex head flanged bolts. Install into coupling nuts while securing heat exchanger mounting brackets. Torque to 130 in/lbs.



159. **(2007+ models only)** Install the heat exchanger to the factory 2 bolts on the lower (2) holes of the heat exchanger. Use the supplied (2) 8mm flanged nuts to secure heat exchanger. Use the supplied (2) 8mm x 16mm hex headed flange bolts to factory holes to secure upper portion of heat exchanger.
160. Install the electric pump mounting bracket to the (2) 8mm driver side (driver side of frame rail) coupling nuts you previously installed. Apply light amount of red Loctite to the supplied (2) 8mm x 16mm hex head flanged bolts. Install the (2) 8mm x 16mm hex head flanged bolts and torque to 130 in/lbs.

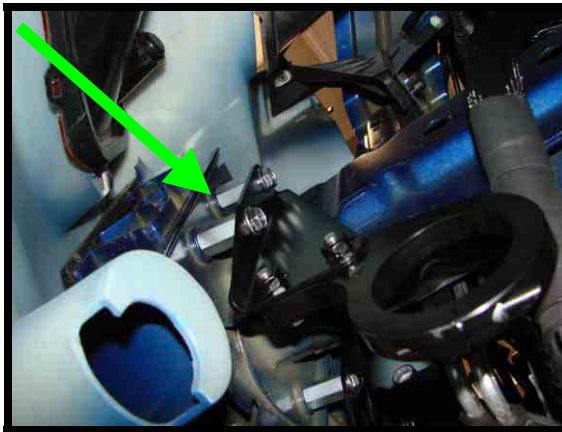

161. Slide the pump through the billet pump collar from the driver side (drivers seat view) so the discharge nipple faces to the front of the vehicle, level with the ground, install the supplied (1) 6mm x 16mm socket head cap screw into collar and tighten to 100 in/lbs.

162. Install the 90deg rubber hose you routed earlier from the IC tank to pump (PN#) to the inlet nipple on the pump. Secure with supplied pinch clamp.

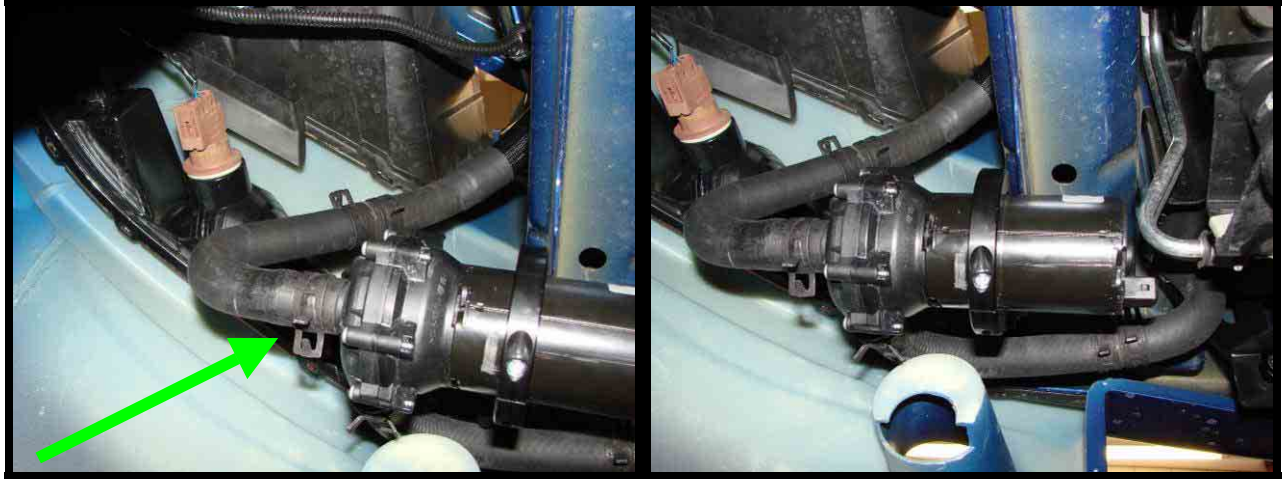

163. Install the pump to heat exchanger hose (PN#46301935) to the pump discharge nipple. Secure with pinch clamp.

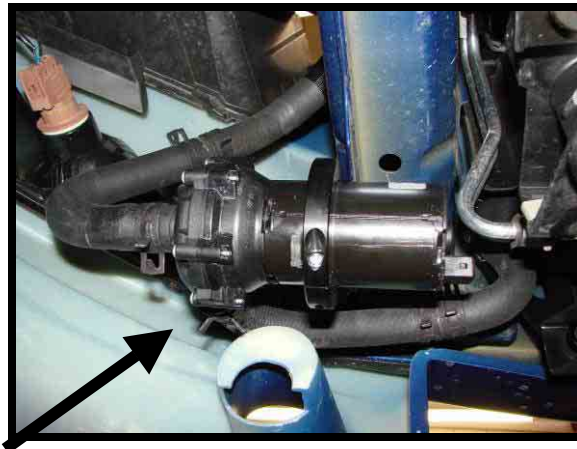

164. Route other end of the pump to heat exchanger hose (PN#46301935) to the driver side heat exchanger 3/4" OD nipple. Secure with supplied pinch clamp.

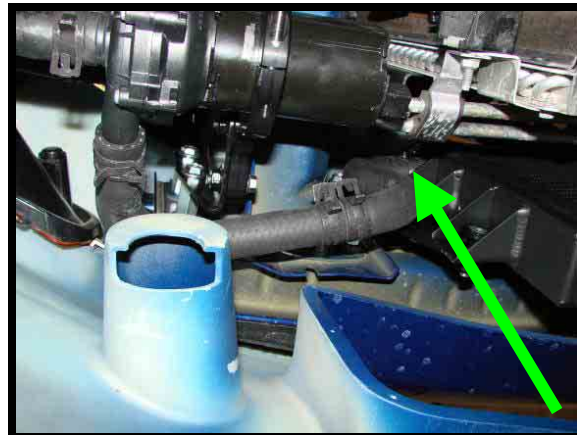

165. Install the pre-routed IC feed hose (PN#46301925) to the passenger side 5/8" heat exchanger nipple. Secure with supplied pinch clamp.
166. (2010 heat exchanger and water pump) The radiator (heat exchanger) for the intercooler system will be mounted in a different location for the 2010 model. To do this installation, the front fascia will need to be removed. The following instructions will guide you thru the process.
167. 2010 Remove the plastic radiator cover from the vehicle. This piece will need to be trimmed to clear the air box.



168. 2010 Remove the lower front splash guard from the underside of the vehicle.



169. 2010 Unhook the sensor from its mount on the front spoiler.



170. 2010 Unplug the lower front side indicator lights. You will be able to access them from under the car once the splash guard is removed.

171. 2010 Start unbolting the front fascia. Remove the two bolts on the outer edge of the fender well on both sides.



172. 2010 Remove the two M6 bolts that are located by the headlamps.



173. 2010 Once the bolt is removed, pull the tab up to unclip it from the mount.



174. 2010 Pull the fascia forward to access the fog lamp plugs. Unplug the fog lamps. Carefully separate the fascia from the fenders. They are just clipped in and will require you to pull on them to unclip



175. 2010 Once the outer edges of the front fascia are free from being wrapped around the fender, you may carefully remove it.



(2010) You are now prepared to start the installation of the heat exchanger and the intercooler hoses. The heat exchanger brackets will be different for this model, but will assembled to the heat exchanger the same way using the (4) M8 x 35 FHSCS.

The brackets should be mounted as follows.

176. 2010 The larger hose barb (3/4") on the heat exchanger will be positioned at the top of the driver's side. The bracket should look as follows. (Viewed as if you are standing in front of the car looking at it).



The smaller hose barb (5/8") on the heat exchanger will be positioned at the bottom of the passenger's side. The bracket should look as follows. (Viewed as if you are standing in front of the car looking at it)

177. 2010 Thread the supplied coupling nuts onto the studs extending from the backside of the bumper. You will do this in 4 places



178. 2010 Install the heat exchanger. Secure the heat exchanger brackets to the coupling nuts using the (4) M8 x 16 hex head flange bolts provided. Make sure the larger hose barb from the heat exchanger is at the top on the driver's side.



179. 2010 Install the intercooler water pump bracket. This bracket will lay on top of the hood latch mount using the factory bolts to secure it.

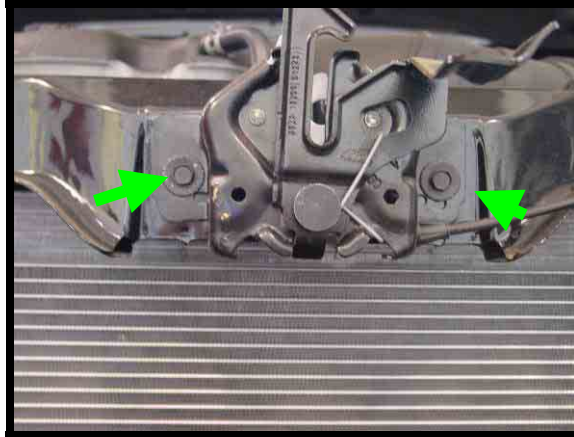

180. 2010 Make note of the hood latch position. You can mark the location with tape. Unbolt the hood latch. Lay the bracket on top of the latch. Secure to car using factory bolts.

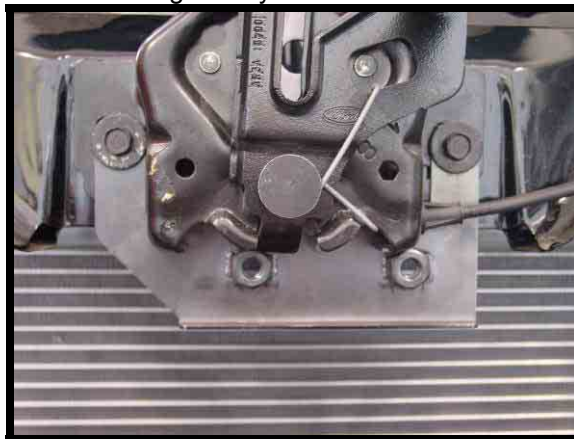

181. 2010 The water pump will be provided with a rubber mounting bracket that will be bolted to the bracket that you just installed. Secure the water pump mount to the bracket using (2) M8 x 16 hex head flange bolts provided. The pump itself may need to be rotated in the rubber mount to position the exit hose barb in the correct location. The barb should be pointing downward behind the heat exchanger.

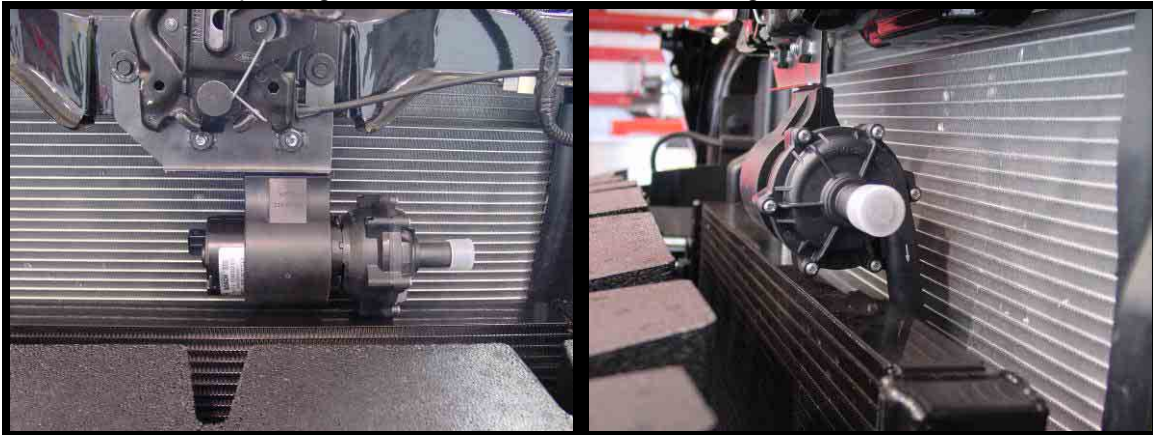

182. 2010 Use the water pump hose (#46302935) to connect the water pump (exit barb) to the heat exchanger. Secure the hose to the barb fittings using (2) constant tension hose clamps provided.



183. 2010 Route the intercooler feed hose assembly (#46302925 h/e to i/c) from the heat exchanger to the intercooler.

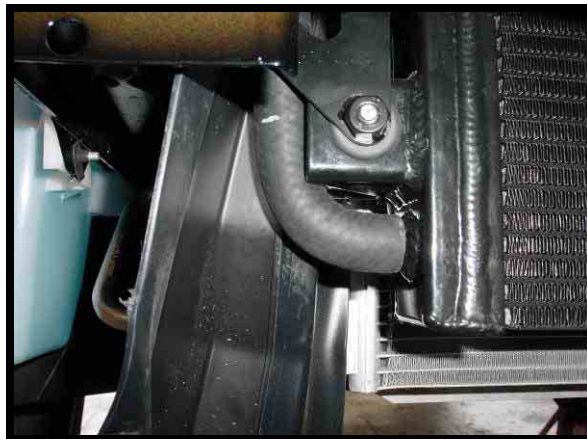

184. 2010 You will need to trim the plastic that surrounds the radiator to properly route the hose. Trim the corner of this piece out and route the hose up to the intercooler fitting threaded into the discharge casting.

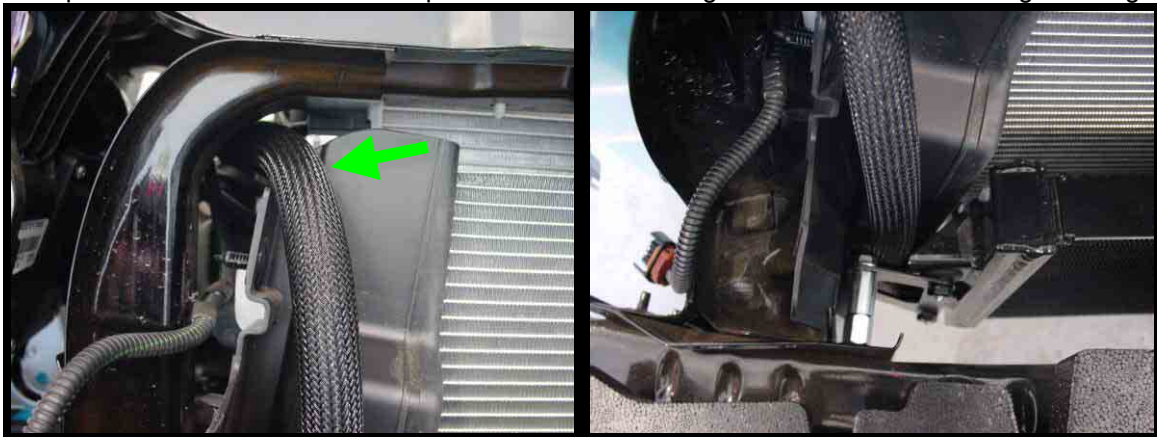

185. 2010 Secure the hose to the hose barbs using (2) constant tension hose clamps provided.

186. 2010 Route the water pump hose assembly (#46302930 tank to pump) from the intercooler reservoir (tank) to the pump. This hose will be routed thru the front scoop used in the factory cold air intake. The center piece of the cold air intake must be removed.

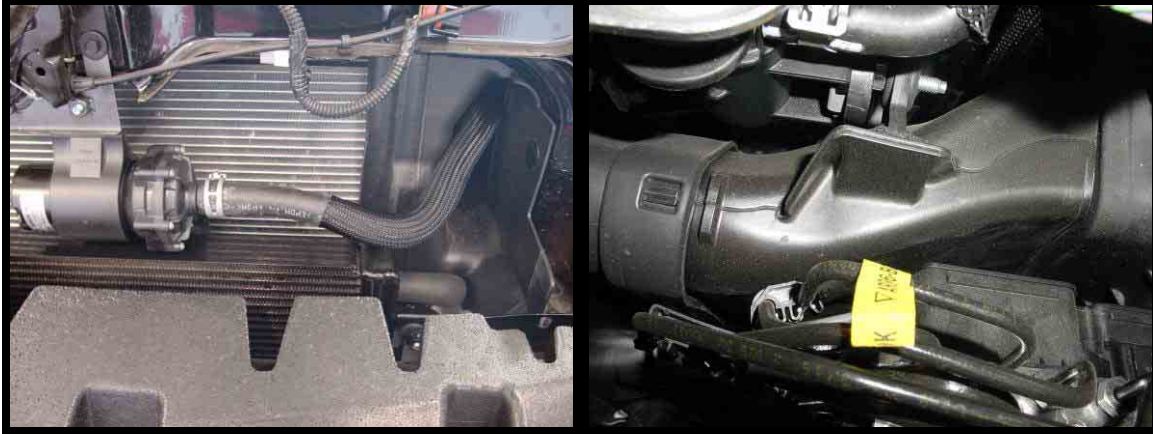

187. (05-06 only) Install electric water pump relay bracket to passenger side strut tower. Secure with the supplied (2) 6mm x 12mm button head allen bolts.



188. (2007+ models) Install electric water pump relay to factory/passenger-side strut tower in the tapped hole. Use (1) 6mm x 12mm button head cap screw. Secure the plastic fuse holder to relay with zip-tie.
189. Install the supplied relay and fuse to the installed bracket. Utilize the supplied (2) 6mm x 12mm button head allen bolts and (2) 6mm nyloc nuts for the relay. Utilize the supplied (1) 5mm x 12mm button head allen bolt and (1) 5mm nyloc nut for the fuse holder.



190. Remove the factory ground wire from the passenger side strut tower 6mm bolt using a 10mm socket. Install IC relay ground eyelet under factory wire and reinstall factory 6mm bolt.



191. Remove the factory fuse cover from fuse box.
192. Remove the factory 6mm power bolt from fuse box with a 10mm socket. Install the IC relay red wire and eyelet under factory power wire and reinstall 6mm bolt.



193. Route the IC relay gray wire to the passenger side front resistor. Cut the factory resistor black wire in the middle of the resistor and one-way connector.



194. Strip the end of the 3 wire ends. Use the supplied barrel crimp connector and secure to the end coming from the resistor. Slide the supplied heat shrink over the barrel crimp connector and wire to the resistor.
195. Connect the gray wire and factory black wire and twist the ends together, install into barrel crimp connector and crimp. Slide heat shrink over wires, apply heat to tubing until the glue comes out and it shrinks.



196. Route the pump 2-way connector down the passenger side of engine, through the cross member and down to the pump. Push until it snaps in place.

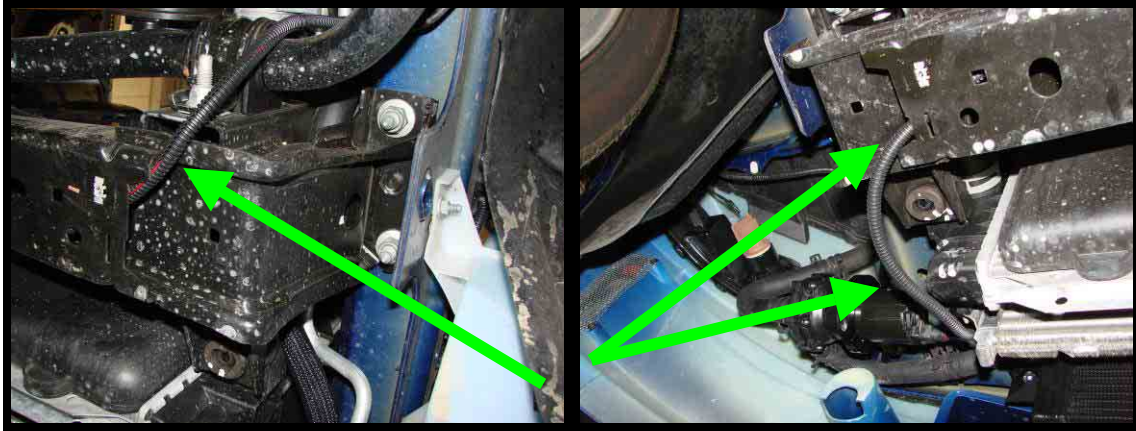

197. (INTERCOOLED/HIGH OUTPUT) FUEL PUMP INSTALLATION.

⚠ WARNING!! Do not smoke or carry lighted tobacco or open flame of any type when working on or near any fuel-related component. Highly flammable mixtures are always present and may be ignited, resulting in possible personal injury.

⚠ WARNING!! Fuel in the fuel system remains under high pressure even when the engine is not running. Before servicing or disconnecting any of the fuel lines or fuel system components, the fuel system pressure must be relieved to prevent accidental spraying of fuel, resulting in personal injury or a fire hazard.

⚠ WARNING!! Do not carry personal electronic devices such as cell phones, pagers or audio equipment of any type when working on or near any fuel-related components. Highly flammable mixtures are always present and may be ignited. Failure to follow these instructions can result in personal injury.

⚠ WARNING!! This procedure involves fuel handling. Be prepared for spillage at all times and always observe fuel handling precautions. Failure to follow these instructions can result in personal injury.

198. Remove the rear seat bottom and any insulation padding covering the fuel pump access cover. From under the front of the rear cushion assembly, push in the seat cushion release tab located on the left and right of seat, lift and remove the rear cushion assembly.



199. Remove black plastic cover from inside trunk to access fuel pump driver module. There are two plastic wing nuts and two plastic clips holding this piece in.



200. Remove the carpet from the trunk for better access to the fuel pump driver.
201. Run connectors labeled **DUAL PUMP CONNECTOR** and **SENDER CONNECTOR** along the wall of the driver side of trunk, under rear seat, and into rear seat area where the pump access hole is located.



202. Remove the driver side fuel pump access cover by carefully lifting up with a flat head screw driver.



203. Disconnect the fuel pump electrical connector (driver side).



!! CAUTION !! If the liquid or vapor tube is damaged (torn, holes or delaminated), the affected tube assembly must be replaced with a new tube assembly. Do not use aftermarket sleeving. Do not re-adhere loose sleeving material.

!! CAUTION !! When reusing liquid or vapor tube connectors, make sure to use compressed air to remove any foreign material from the connector retaining clip area before separating from the tube. Apply clean engine oil to the end of the tube before inserting the tube into the connector.

!! CAUTION !! Fuel injection equipment is manufactured to very precise tolerances and fine clearances. It is therefore essential that absolute cleanliness be observed when working with these components. Always install blanking plugs to any open orifices or tubes.

204. Disconnect the fuel tube quick connect coupling on the fuel pump (driver side).

- Press the fuel tube quick connect coupling button and pull the fuel tube to disconnect.



205. Using a fuel tank lock ring wrench or a brass punch, remove the fuel pump retaining lock ring.



!! CAUTION !! The fuel pump must be handled carefully to avoid damage to the float arm, filter, and the convolute hoses.

206. Carefully lift the fuel pump out of the fuel tank enough to access and release the fuel cross-over tube quick connect coupling from the fuel pump.



207. Completely remove the fuel pump from the fuel tank.

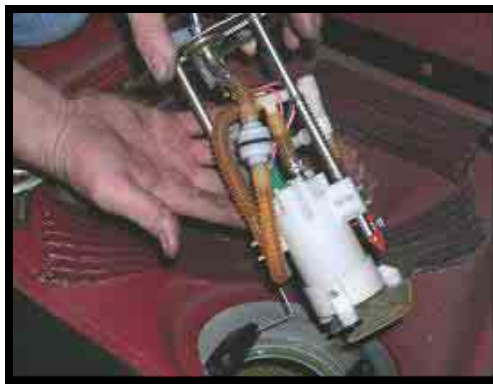

!! CAUTION !! Inspect the surfaces of the fuel pump mounting flange and fuel tank O-ring seal contact surfaces. Do not polish or adjust the O-ring seal contact area of the fuel tank flange or the fuel tank. Install a new fuel tank if the O-ring seal contact area is bent, scratched or corroded.

!! CAUTION !! Make sure to install a new fuel pump O-ring seal and lock ring.

208. To install, apply clean engine oil to the O-ring seal.

209. Install new fuel pump O-ring seal.



210. Position the dual fuel pump into the fuel tank.

211. Connect the cross-over fuel tube quick connect coupling to the fuel pump.

- Make sure the fuel tube clicks into place when installing the tube. To make sure that the fuel tube is fully seated, pull on the tube.**

212. Make sure the alignment arrows on the dual fuel pump and the fuel tank meet before tightening the dual fuel pump lock ring. Using the special tool or brass punch, install dual fuel pump with new lock ring.

- Tighten the lock ring until it meets the stops on the fuel tank. **NOTE:** The fuel pump is spring loaded into tank and may require slight pressure to install lock ring.

213. Connect the quick connect coupling on top of the dual fuel pump.

- Make sure the fuel tube clicks into place when installing the tube. To make sure that the fuel tube is fully seated, pull on the tube.**

214. Disconnect fuel pump driver module located in spare tire well on driver side.



215. Mount additional fuel pump driver module in spare tire well on opposite side (passenger side of trunk) of existing fuel pump driver using the supplied 2 sheet metal screws.



216. Mount **RELAY** from harness on inside of tire well to the left of the stock fuel pump driver module.



- 217. Connect connector labeled **FPDM BODY SIDE CONNECTOR** into the harness where the existing fuel pump driver module was connected.
- 218. Connect connector labeled **FPDM NO. 1** to stock fuel pump driver module.
- 219. Mount wires labeled **RELAY GROUND** and **FPDM NO. 1 GROUND** in hole next to stock ground using ground screw.



- 220. Connect connector labeled **FPDM NO. 2** to newly mounted fuel pump driver module on passenger side.
- 221. Mount wire labeled **FPDM NO. 2 GROUND** to stock ground location on rear/passenger side of trunk area..

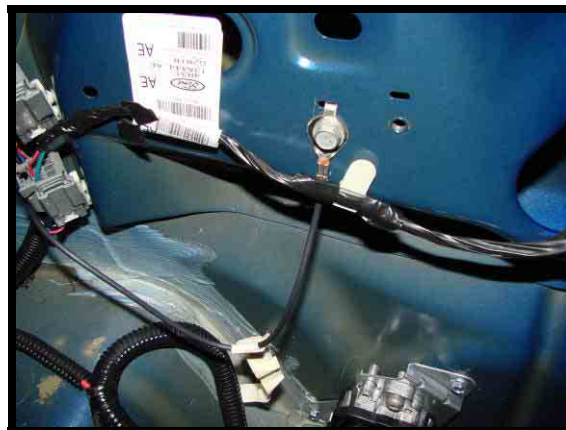

222. For 05' Mustang GT, a 1 ½" diameter hole will need to be cut out in the center of the access cover for the fuel pump.
223. For 06' Mustang GT and beyond, a second hole with a 1 ½" diameter will need to be cut into the access cover. The hole should be a ½" away from existing hole to allow clearance for the new grommet to seal. Do not take the existing harness out of the existing hole in the access cover.



224. Once hole is cut out, pull **DUAL PUMP CONNECTOR** and **SENDER CONNECTOR (1)** through hole and seal hole with grommet. Unlock the existing 4-pin female connector (connector on the end of the existing harness going through access cover) previously connected to the stock fuel pump. Unlock the connector by pulling the blue center piece forward.

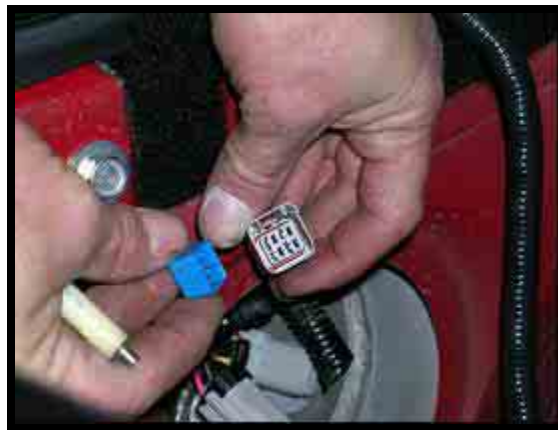

- Release terminals for the LB/YE (pin 2) wire and the LG/VT (pin 4) wire from the connector housing. Do not remove terminal from wire. These are the fuel sender wires.

225. Insert fuel sender wires into the connector labeled **SENDER CONNECTOR (2)** with the LB/YE (pin 1) wire going into left side and the LG/VT (pin 2) wire going into the right.



226. Connect **SENDER CONNECTOR (1)** into **SENDER CONNECTOR (2)**. Once connection is made, the LG/VT wire should line up with the RD/YE wire and the LB/YE wire with the BK wire.
227. Connect the **DUAL PUMP CONNECTOR** to the newly installed dual pump.
228. Reinstall access cover.



229. Run wire labeled **FUSE/POWER (1)** along the trunk wall, into the back seat of the passenger side, and along the wire track on the passenger side of vehicle.



A hole will need to be placed in the grommet located in the lower area of the front wall on the passenger side in order to run the wire through.

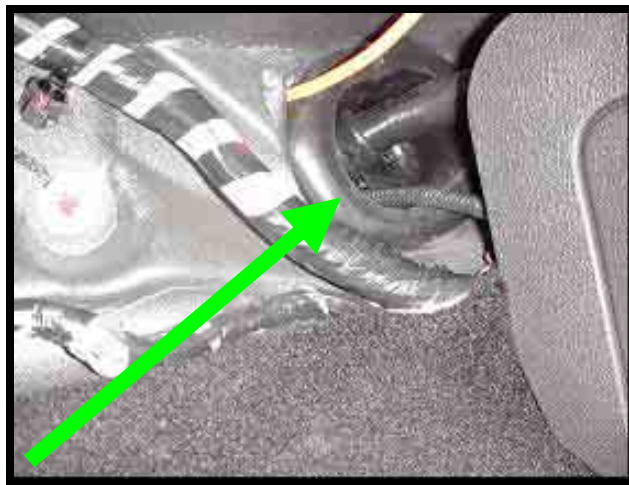

230. Lift vehicle and remove the right front tire from vehicle along with the rear fender well cover. Continue to run wire along existing wire harness in fender well using wire ties to secure the wire along the existing wire harness.



231. Remove innermost fastener on front fender well cover and continue to run wire into the engine compartment. The wire should come through the hole located near the washer fluid neck.



232. Connect **FUSE/POWER (1)** to **FUSE/POWER (2)**.
233. Connect **POWER** to hot side of bussed electrical center.



234. Reinstall relay in position 21 of bussed electrical center.
235. Locate the TPS connector (4-pin) (Gray-white, Black-green, Red-white, Yellow-white). Measure approximately 5" from connector end and cut the wires at equal length.

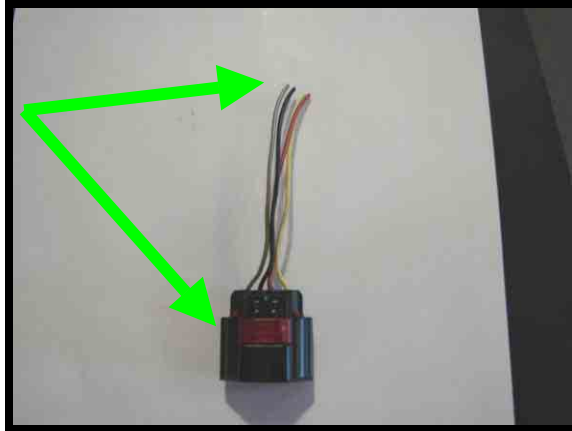

236. Using the supplied wire and barrel crimp connectors, crimp the corresponding color wires to the cut end coming from the engine wiring harness. Install supplied heat shrink over the barrel crimp connectors. Using a heat gun or blow dryer, apply heat to the heat shrink tubing until it shrinks over the exposed wire and the glue is released from the heat shrink. **⚠ WARNING!!** The glue must release from the heat shrink or it won't seal properly! Cover wire with supplied plastic split loom.

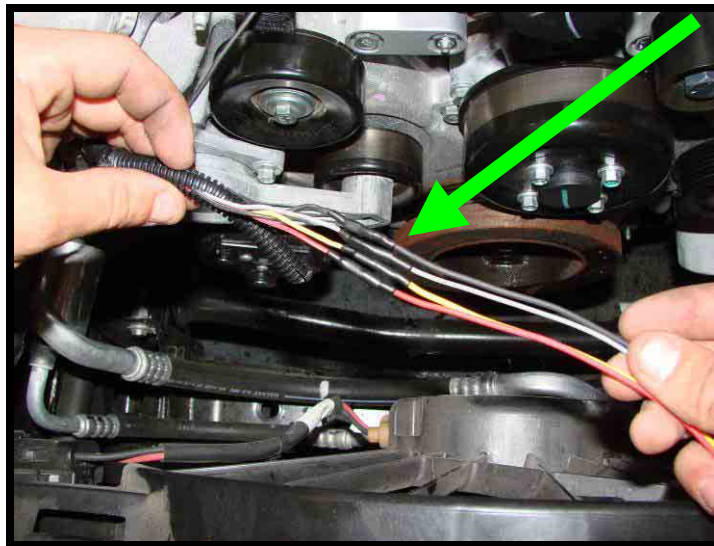

237. Route the TPS extended wires around the back side of the supercharger and to the TPS to get the proper length. Install the supplied heat shrink over the exposed wires. Use the supplied barrel crimp connectors, crimp the corresponding color wires to the TPS connector. Slide the heat shrink tubing over the barrel crimp connectors and use a heat gun or blow dryer to apply heat to the heat shrink tubing. Apply heat until it shrinks over the exposed wire and the glue is released from the heat shrink. **⚠ WARNING!!** The glue must release from the heat shrink or it won't seal properly! Cover wire with supplied plastic split loom.
238. Plug TPS connector to TPS sensor on throttle body.

239. Locate the Electronic throttle connector (2-pin) (Orange-yellow, Blue-yellow). Measure approximately 4" from the end of the connector and cut the wires at equal length.

240. Using the supplied wire and barrel crimp connectors, crimp the corresponding color wires (electronic throttle connector) to the cut end coming from the engine wiring harness. Install the heat shrink over the barrel crimp connectors. Apply heat until it shrinks over the exposed wire and the glue is released from the heat shrink. 

WARNING!! The glue must release from the heat shrink or it won't seal properly!

241. Install the supplied heat shrink over the extended electronic throttle wires, connect the electronic throttle connector to the corresponding extended wires with the barrel crimp connectors. Apply heat until it shrinks over the exposed wire and the glue is released from the heat shrink.  **WARNING!!** The glue must release from the heat shrink or it won't seal properly! Cover wire with supplied plastic split loom.

242. Connect the electronic throttle connector to the electronic throttle motor electrical connection.

243. Locate the MAF connector (6-pin) (Purple-yellow, Black-white, Tan-blue, Light Blue-red, Gray-red, Gray). Measure approximately 4" from the end of the connector and cut the wires at equal length.

244. Using the supplied wire and barrel crimp connectors, connect the corresponding color wires to the cut end coming from the engine wiring harness. Install the heat shrink to the solder joints.  **WARNING!!** The glue must release from the heat shrink or it won't seal properly!

245. Install the supplied heat shrink over the extended MAF wires, crimp the MAF connector to the corresponding extended wires. Slide the heat shrink tubing over the barrel crimp connectors and use a heat gun or blow dryer to apply heat to the heat shrink tubing. Apply heat until it shrinks over the exposed wire and the glue is released from the heat shrink.  **WARNING!!** The glue must release from the heat shrink or it won't seal properly! Cover wire with supplied plastic split loom.

246. Install the plastic 3/8" ID 90deg quick connect fitting (hose #46301945) to the passenger side valve cover fitting. Push until it clicks in place.

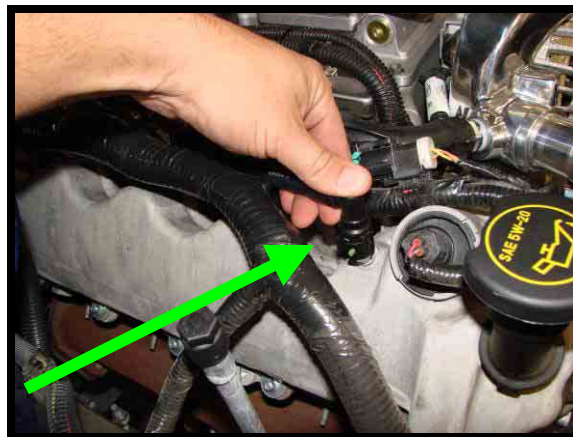

247. Route 3/8" ID rubber vent hose (PN# 46301915) between the supercharger and supercharger adapter housing, then back towards the front, just below the throttle body.



248. Remove the factory MAF element from the factory air filter assembly by removing the (2) torx bolts (T20 torx socket).



2008-2010 air filter box see page 82

249. 05-07 Remove the factory rubber grommets (2) from the bottom of the factory air filter assembly.

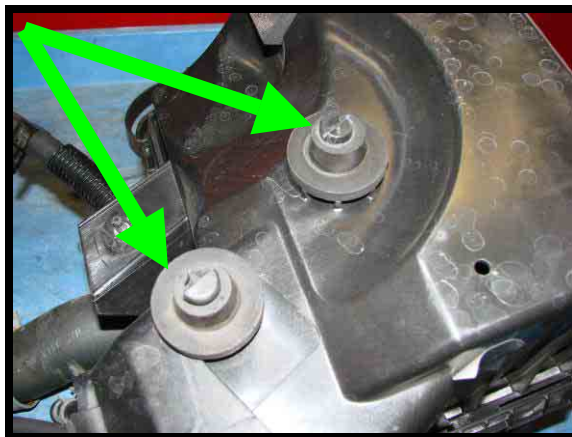

250. 05-07 Install the factory rubber grommets (2) the bottom of the new cold air intake assembly.



251. 05-07 Install the MAF housing and air venture to air filter box. The venture goes on the inside of the air box while the MAF housing goes on the outside. Position the MAF housing so it's facing up and towards the driver side as shown in the following figure. Secure with the supplied (4) 6mm socket head allen bolts.



252. 05-07 Install MAF element into new 95mm MAF housing using the factory torx bolts (2) (T20 torx socket).
NOTE: Some Mustangs were equipped with plastic style fasteners, if so, utilize the supplied 4mm bolts supplied.



253. 05-07 Install the new air filter to cold air inlet, secure with supplied clamp (5/16" nut driver).



254. 05-07 Remove the factory (1) 8mm bolt from the front clip (holds ABS system in place) (10mm socket).



255. 05-07 Install new cold air intake assembly by dropping the air box rubber grommets in the factory location. Secure cold air intake front brace by utilizing the factory 8mm bolt (1) (10mm socket). Torque to 130 in/lbs. Secure the rear cold air assembly brace by using the supplied (1) 6mm x 20mm hex head bolt. Torque to 130 in/lbs.
256. 05-07 Connect the MAF connector to the MAF element.
257. 05-07 Install the supplied hump hose to the factory throttle body and secure to throttle body using the supplied (1) #72 hose clamp (5/16" nut driver).



- 258. 05-07 Install the supplied 4" silicone hose over the plastic inlet duct as well as the (2) supplied #64 hose clamps. Slide the silicone hose as far up as possible for easier installation of the plastic air inlet ducting.
- 259. 05-07 Install the oval end of the plastic air inlet duct to the throttle body/hump hose and lift up, install the vent hose to the 3/8" plastic barb. Line up the plastic duct with the MAF housing. Secure the hump hose side with the supplied (1) #72 hose clamp (5/16" nut driver). Secure the MAF to plastic duct hose with the supplied (2) #64 hose clamps (5/16" nut driver).

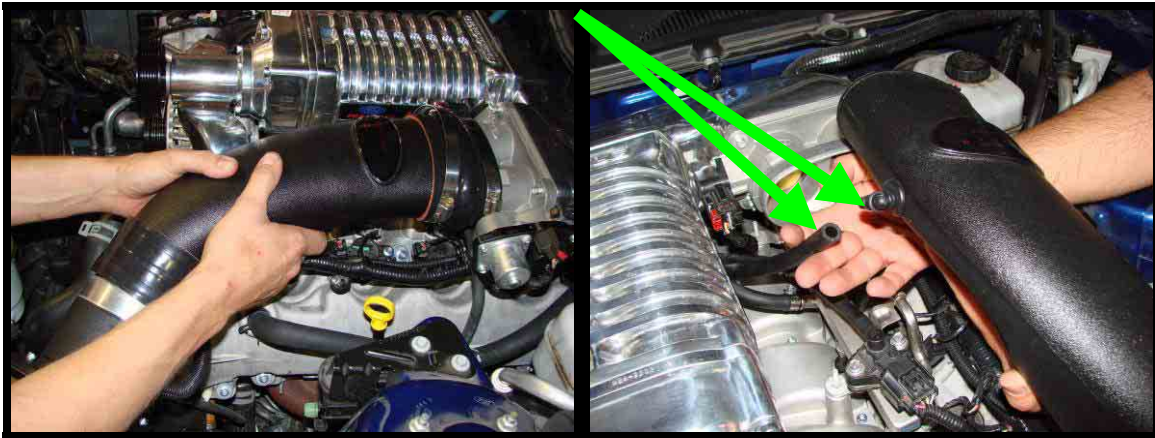

- 260. (08-10) The air intake system for the 2008-2010 Mustang supplied with the supercharger kit will replace the factory system. The air box containing the filter element will be installed in the factory location using (1) existing bolt and (1) supplied bolt.

261. (08-10) Once the factory air intake system is removed, remove the MAF sensor from the factory air intake lid and secure it to the new 90 deg intake elbow using the (2) supplied M4 x 16 button head cap screws and the (2) supplied M4 nylock nuts and the sealing plate



262. (08-10) Remove the top bolt that secures the brake control unit to the car. The new air box will sit on top of this bracket and will be secured using the factory bolt.



263. (08-10) The other molded in bracket of the air box will sit on the driver's side fender and use the existing factory j-nut and the provided M6 hex head flange bolt to secure it to the car

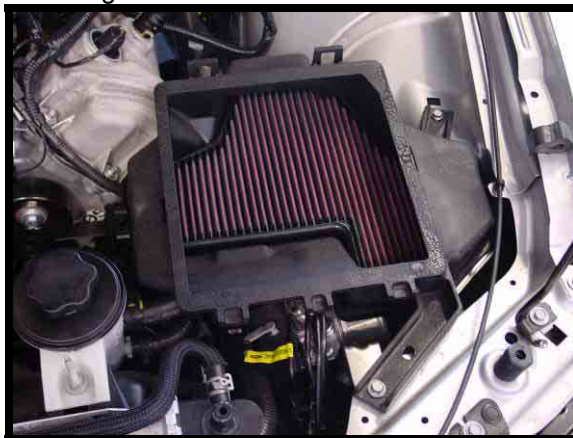

264. (08-10) The long bracket on the new air box has two holes. The hole furthest away from the main body of the box is used for the 2010 model. The hole closest to the main body of the box is used for the 08-09 models. The bracket will be trimmed to a shorter length when sold for the 08-09 models.

The top lid will clip onto the air box using the three molded in posts and the two factory like clips.



265. Position the air box as shown leave the bolts loose at this time.

266. (08-10)_The supplied 4.25" silicone hump hose will connect the throttle body to the smaller side of the oval intake tube which has the bead on it. Slide the hump hose on as shown to edge of radius 7/8" then Using (1) of the #72 hose clamps, secure the hump hose to the oval air intake tube.

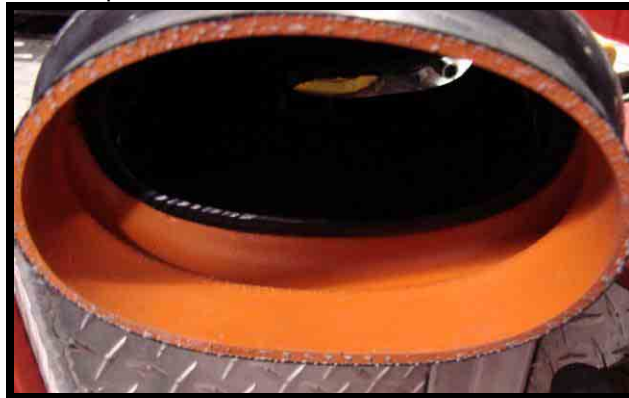

267. (08-10) The plastic 90 degree fitting on the side of the oval air intake tube should be on the supercharger side. push the hump hose air tube assembly onto the throttle body with (1) of the #72 hose clamps leave loose at this time



268. (08-10) connect the pcv line from the passenger side valve cover to the plastic 90 degree fitting on the side of the oval air intake tube

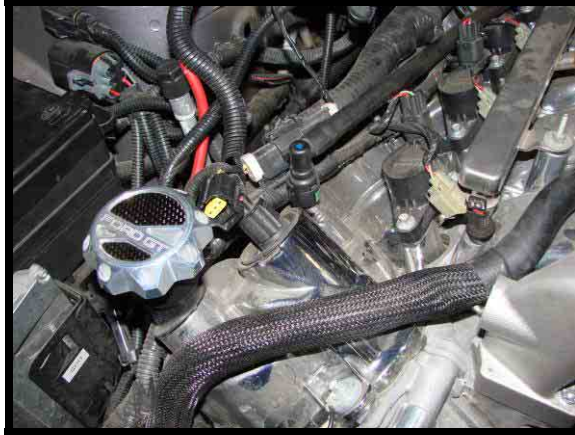

269. (08-10) The supplied 4.5" silicone straight hose will connect the larger end of the oval air intake tube to the 90 degree elbow coming out of the air box lid. Push the hose 1/2 way onto the 90 degree elbow with a clamp leave loose Slide (1) of the #72 hose clamps loosely over tube then push the 90 assembly into the straight air tube make sure airbox lid can drop into place



270. 2007-2010 latch the airbox lid pull the bottom of box up and push tab forward

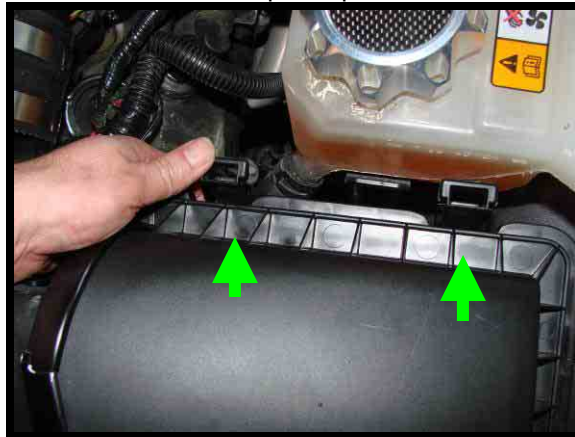

271. 2007-2010 Make sure the air tube and box are sitting all the way down then tighten the clamps and air box bolts (it may help to make sure the air box is over towards the fender as far as possible)



272. Install the factory radiator hose to water cross over fitting. Secure with factory pinch clamp.

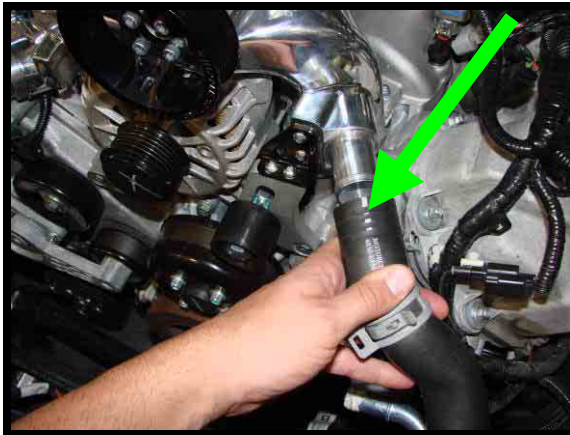

273. (05-06 models only, 07+ models skip this step) Reinstall the radiator to water cross over rubber hose and secure with factory pinch clamp.

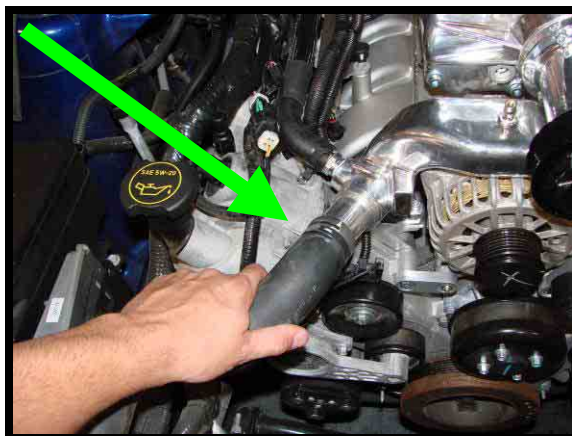

274. Reinstall the coolant overflow tank to factory location. Secure with the factory (2) 6mm bolts (8mm socket).



275. Reinstall the upper coolant overflow hose to overflow tank. Use factory pinch clamp to secure.



276. (05-06 models only, 07+ models skip this step) Reinstall the thermostat housing to overflow tank hose. Secure with factory pinch clamp.

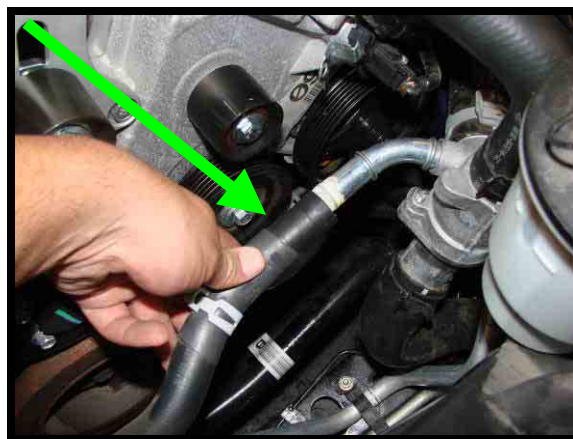

277. Fill the new s/c compressor with oil per supplied instructions.

!! CAUTION !!

Severe damage to the compressor will occur if you overfill the supercharger front gear case.

- Make sure the SC is sitting square/flat.
- Remove -4AN allen plug (3/16" allen wrench) and fill SC with **WHIPPLE SC OIL ONLY!!**
- Fill to the middle of the sight glass. NOTE: The W140AX compressor takes a maximum of 5.8 fl/oz.
- Reinstall -4AN allen plug.
- NOTE: After running the SC, the oil level will lower due to oil filling the bearings. The proper level while **not running** should be between the bottom of the sight glass and the middle and will vary when running and not running.
- Change SC oil every 100,000 miles and only use **WHIPPLE SC OIL ONLY!!**

!! CAUTION !!

Severe damage to the compressor will occur if you overfill the supercharger front gear case.

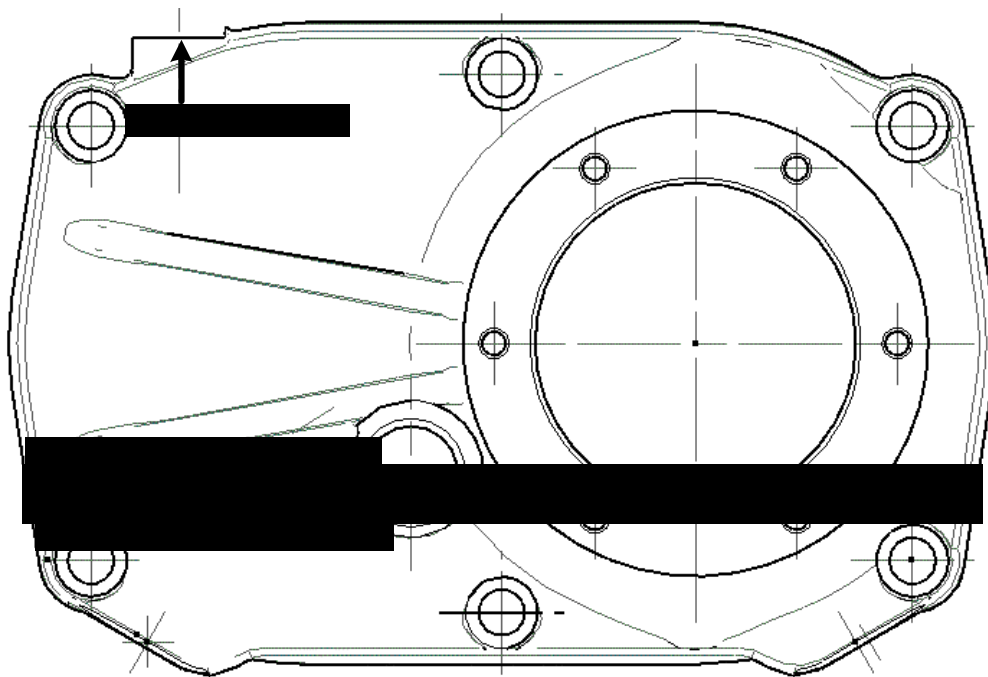

!! CAUTION !!

Severe damage to the compressor will occur if you overfill the supercharger front gear case.

278. Reconnect the battery ground connector.

279. Refill the engine coolant system with a 60% (distilled water)/40% (coolant such as Zerex G-05) mix of distilled water and **Ford approved engine coolant**. Whipple also recommends running 1 bottle of Redline Water Wetter which can be found at most automotive parts stores. **⚠ WARNING!! DO NOT USE TAP WATER**

OR ANY NON FORD APPROVED ENGINE COOLANT, THIS WILL CAUSE CORRISION IN THE SYSTEM. Start engine to completely fill system. Using a flat head screw driver, bleed the air-pockets from the cooling system. You must wait until the thermostat opens, which is after 160deg F. Use a rag to stop the coolant from spraying everywhere. Tighten bleed fitting when done.



280. Fill the IC system with a 60% (distilled water)/40% (coolant such as Zerex G-05) mix of distilled water and **Ford approved engine coolant**. Whipple also recommends running 1 bottle of Redline Water Wetter which can be found at most automotive parts stores. **⚠ WARNING!! DO NOT USE TAP WATER OR ANY NON FORD APPROVED ENGINE COOLANT, THIS WILL CAUSE CORRISION IN THE SYSTEM.** Start engine to completely fill system.
281. Using your Ford Racing flash tool, follow the detailed instructions to reflash your factory PCM.
282. Start engine and check for any fuel or coolant leaks.
283. **⚠ WARNING!!** Verify the bypass actuator is working properly. To monitor, look at the bypass arm when the motor is not running. Start engine and verify that the actuator arm has opened. This arm will be extended when the engine is above 1" of vacuum (boost) and will be open when there is more than 1" of engine vacuum

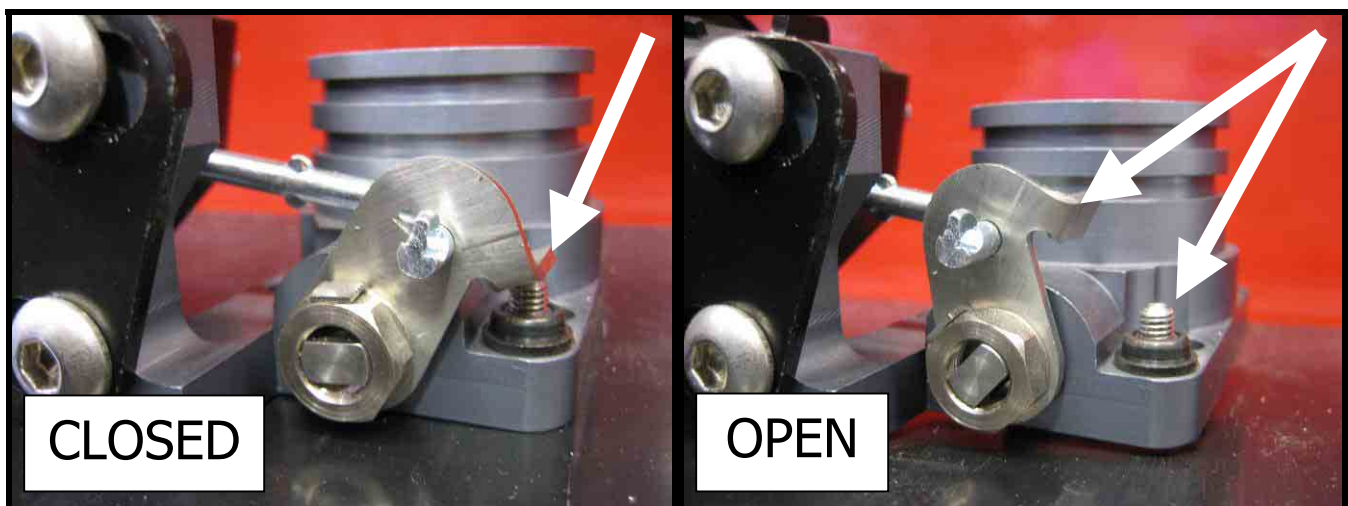

BELT, PULLEY AND IDLER MATRIX

PULLEY SIZE	BELT SIZE	IDLER PULLEY SIZE	SPRING LOADED TENSIONER	NOTES
3.000	122.3	76MM	76MM	
3.125	122.3	76MM	76MM	
3.250	124.7	100MM	90MM	
3.375	124.7	100MM	90MM	
3.500	124.7	90MM	90MM	
3.625	124.7	90MM	90MM	
3.750	124.7	90MM	76MM	ALL FACTORY IDLER'S
3.875	124.7	90MM	76MM	ALL FACTORY IDLER'S
Pulley torque to 120-130 inch lbs		All Idlers torque to 25 ft/lbs		

Maintenance and Service

Be sure to follow the maintenance and service recommendations below to optimize the life and performance of your Whipple-supercharged mustang.

Maintenance

For best performance and continued reliability it is essential to adhere to the following guidelines:

1. Use only premium grade fuel (91-octane or higher).
2. Always listen for any sign of spark knock or pinging. If present, discontinue use immediately and consult your vehicle owner's manual.
3. Do not overfill the supercharger front gear case.

!! CAUTION !!

Severe damage to the compressor will occur if you overfill the supercharger front gear case.

4. Do not operate the vehicle at large throttle opening if the MIL lamp is on steadily. This indicates an electronic engine control malfunction: reduce throttle opening and consult your vehicle dealer.
5. HIGH HP cars (12psi+) should inspect the actuator every 10,000 miles.
6. Inspect and clean your high-flow air filter element every 7,500 miles.
7. Inspect and replace spark plugs every 30,000 miles.
8. Replace your factory fuel filter every 10,000 miles.
9. Inspect the bypass actuator operation every 10,000 miles.
10. Follow your factory service intervals for oil changes and other typical maintenance items.

!! CAUTION !!

Any modification to your vehicle's new computer program may cause serious damage to the engine and/or drivetrain.

BYPASS ACTUATOR TESTING

⚠ WARNING!! MUST BE VERIFIED BEFORE TEST DRIVING

1. Plunge the actuator arm into the actuator.
2. Plug the top port with finger or rubber cap.
3. Release the actuator arm while still capping the top port.
4. Verify that the arm only slightly moved, if it went back to the closed position (resting on stop), then the actuator is ruptured/damaged and needs to be replaced IMMEDIATELY. If it checks ok, then re-install the 7/32" hose and secure with tie-wrap.

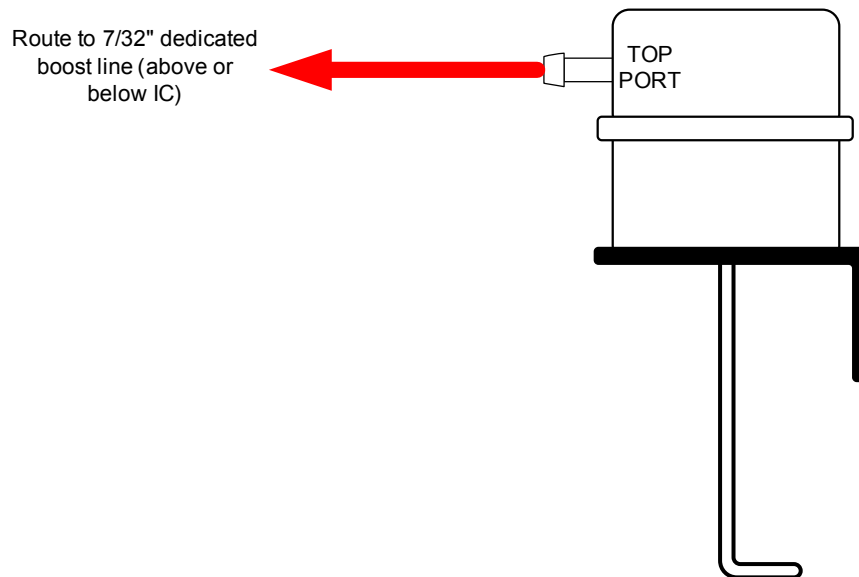

Servicing Your Supercharger

It is recommended that the following items be inspected at normal service intervals:

1. Check the supercharger oil level at every engine oil change. Add Whipple SC oil to the supercharger if required.
2. Check the supercharger/accessory drive belt. Adjust or replace as required.
3. Change the oil in the supercharger every 100,000 miles. Use Whipple SC oil only.

Follow these guidelines to properly maintain your Whipple-Supercharged Ford Mustang

Post-Installation Checklist

After installing the Whipple supercharger kit it is essential that the following checklist be completed.

!! CAUTION !!

Failure to complete the Post-Installation Checklist may result in severe engine damage.

1. Review the Maintenance and service section and familiarize yourself with the steps you must take to ensure your Whipple-supercharged truck/SUV will continue to operate with optimum performance.
2. Verify Fuel Octane: When you re-fuel your truck/SUV, ensure you use fuel of 91-octane or higher. It will always be beneficial to run 92-94 octane when available.

!! CAUTION !!

Use only 91-octane fuel or higher. If fuel of less than 91-octane is present in the vehicle fuel tank, the tank must be completely drained and refilled with 91 or higher octane to 1/8th of a tank.

3. Check Vehicle Fuel Pressure: Fuel pressure is critical to proper supercharger operation and must be checked during wide-open-throttle operation when the fuel tank is 1/8th full. Fuel pressure should meet all factory specifications.

Checklist Review

Have you completed the Post-Installation Checklist? Be sure you have:

1. Reviewed the Maintenance and Service Recommendations
 2. Verified the Fuel Octane
 3. Checked the Vehicle Fuel Pressure
- Have you completed all items in the **Post-Installation Checklist**?

↻ NOTE

There are no warranties expressed or implied for engine failure or damage to the vehicle in any way during supercharger installation or use.

If you have completed the **Post-Installation Checklist**, you have successfully installed your Whipple FRPP Supercharger Kit.

Congratulations! Your supercharger installation is now complete.

Important information

BOOST LEVELS

All Whipple kits are shipped with approximately 6.5psi (non-intercooled) and 10psi (intercooled) pulleys for stock engines (@ sea level). Additional pulleys are available for lower and higher boost levels, although higher boost levels will void the SC warranty and may need custom PCM calibration. With proper PCM calibration, the factory engine has proven to withstand 8psi (non-intercooled) and 11psi (intercooled) before detonation on 91-octane fuel. Engines with other aftermarket upgrades may see slightly lower boost levels due to increased engine airflow. Whipple does not recommend exceeding 12psi of boost on stock engines without use of race gas.

CAT-BACK EXHAUST SYSTEMS

Whipple recommends a good high flow cat-back exhaust system such as Ford Racing, Borla, JBA and many others. Typically, cat-back exhaust systems do not increase the total power output, but typically lowers the exhaust back pressure. This lowers the overall heat the exhaust creates and decreases the overall boost level. In order to see an increase in power, you typically need to go with a smaller SC pulley to get the boost level back up to the previous boost level, which equates to more total power.

EXHAUST HEADERS

A good set of exhaust headers have shown slight increases in power output depending on the application. Headers will also decrease back pressure, which typically lowers the boost level. Most notably, they typically decrease underhood temperatures and consequently, give the potential for more reliable power. The drop in back pressure decreases heat and helps produce more power. As with the cat-back, the more noticeable gains can be seen when the boost PSI drops and you change the SC pulley to increase the boost PSI back, which gives you more airflow and nets more power.

FUEL SYSTEM

The Whipple/Ford Racing PCM flash and fuel system needs no additional changes for boost levels up to 7psi (non-intercooled and 12psi (intercooled). After 7psi, the factory fuel pump needs to be replaced to a larger size. The intercooled kit's 34lb/hr fuel injectors are good for 12psi, for higher boost levels, Whipple recommends running the EV6 63lb/hr Siemens injectors, available through Whipple. These injectors are available in a short size for easy clearance. Taller injectors will cause a problem under the Whipple air inlet ducting and you would be required to space the fuel rail up and go to an aftermarket fuel rail.

AIR FUEL RATIO

Air fuel ratio is the measurement of the amount of air and fuel being burned during the combustion process. There are currently many different air fuel-monitoring systems and accuracy is not always guaranteed. Wide band oxygen sensors vary over time and deteriorate with uses of leaded gasoline. Whipple only uses Horiba wide band analyzers and UEGO 6-wire sensors, the most accurate available. Our sensors are checked after every use and transfer functions are changed every time so make sure you're using an accurate meter.

Whipple has found that 12.6:1 is approx. the best a/f for power. Be very careful though, too lean of an air fuel ratio increases cylinder temps and increase the chance of detonation, which is detrimental to engine life. Whipple commonly sets stock motors at approx. 11.5:1 although this varies depending on the application. Under custom high boost applications such as 10-12PSI, Whipple recommends 11:1. This is only a rule of thumb because most meters will vary.

FUEL OCTANE

Never run a fuel octane that is below 91octane, (RON+MON)/2. It is recommended, when available, to run 92-94 octane. Never mix mid level (below 91) with 91+, this is very dangerous and can cause severe engine damage. Do not attempt to increase octane ratings with octane boosters, these are very hard on spark plugs and many brands do very little to the actual octane rating. For emergency situations, the best octane booster found to date is made by NOS, the "Off-road" formula has shown to increase the octane rating nearly 2.5 points when mixed at its most concentrated level. Again, this is very hard on spark plugs so constant use will require increased spark plug maintenance and possible cylinder misfire when the plugs foul.

SPARK PLUGS

Whipple supplies new Ford Racing 0 range plugs that are the proper heat range for 6-15 psi. Boost levels above 8psi must close the gap of the plugs to .032" (comes standard in the intercooled kits). These plugs are not like standard plugs and must be done by installing a .032" feeler gauge between the electrode and ground strap, then lightly crush the plug using a vice. Always double check the gap after modifying it. In some cases, if the vehicle is started and stopped multiple times without coming up to temperature, you may get a fouled plug. This will cause erratic idle and cylinder misfiring during operation. If this happens, you must replace the fouled plug immediately.

ENGINE COOLANT

For boost levels above 9psi, Whipple recommends running a 75/25 mix of distilled water and coolant vs. the factory 50/50. We also recommend 1-2 bottles of Red Line Water Wetter coolant additive. This will reduce air bubble insulation, which increases overall engine temp. For moderate boost levels, approximately 6-8psi, we recommend running a 50/50 mix with 1-2 bottles of Red Line Water Wetter.

INTERCOOLER COOLANT AND COOLERS

The supplied intercooler system is very well designed and Whipple saw no increased benefits from any changes below 10psi of boost. For systems that run more than 10psi, Whipple recommends changing the 60/40 ratio to 75/25 distilled water and factory Ford coolant. We also recommend 1 bottle of Red Line Water Wetter coolant additive. If you are running above 15psi, a higher capacity heat exchanger, electric fans and a larger capacity reservoir system is an excellent choice. This will have a higher capacity to maintain low discharge temperatures. When going to larger capacity heat exchangers and reservoirs, you should install one extra bottle of Red Line Water Wetter (2 total).

THROTTLE BODY

Increased bore throttle blades do have beneficial changes. In all cases, the larger blade throttle bodies will have a significant throttle response increase at all given throttle positions and therefore will fill to most as increased power. Before 500hp, gains are very little in overall power output. After 500 hp, you begin to see an increasing performance gain, approx. 5hp @ 500hp and becomes significantly important at levels above 550hp. Be aware that the supplied PCM calibration **WILL** not work with larger bore throttle bodies, custom calibration **WILL** be required.

FUEL LEVEL

Never operate at WOT when the vehicle fuel levels are below a ¼ tank. Low fuel levels could cause the fuel pump to cavitate and you'll have fuel flow spikes resulting in lean conditions and consequently detonation.

BI-FUEL VEHICLES

These supercharger systems are designed to run solely on gasoline and are **not designed** to run the typical 85/15% ethanol mix. The system will run "lean" and may cause serious engine damage  if used.



LIMITED WARRANTY

All merchandise manufactured by Whipple Industries has a limited warranty against defects in workmanship and materials to the original purchaser of the Whipple Supercharger System for one calendar year from Whipple Industries ship date. The limited warranty must be signed, dated and returned to Whipple Industries within 30 days of the Whipple Industries ship date and must be accompanied by a copy of the original sales invoice. This warranty is non-transferable.

If an item is suspected of being defective, return it to Whipple Industries for inspection after obtaining the proper Return Authorization Number. If an item is determined to be defective, we will repair or replace it at our discretion within a period of one year from the shipping date on your invoice.

Whipple Industries Inc. limited warranty specifically does not apply to products which have been (a) modified or altered in any way, (b) subjected to adverse conditions such as misuse, neglect, accident, improper installation or adjustment, dirt, or other contaminants, water, corrosion or faulty repair; or (c) used in other than those specifically recommended by Whipple Industries Inc. All products designed for off-road use are considered racing parts and carry no warranty, either expressed or implied, as we have no control over how they are used.

On warranty items, repair/replacements will be limited to parts manufactured by Whipple Industries and will not include claims for labor or inconvenience. All other merchandise distributed by Whipple Industries is warranted in accordance with the respective manufacturer's own terms of warranty. This warranty is expressly made in lieu of any and all other warranties expressed or implied, including the warranties of merchantability and fitness.

Whipple Industries will not be responsible for any other expenses incurred by the customer under the terms of this warranty, nor shall it be responsible for any damages either consequential, special, contingent, expenses or injury arising directly or indirectly from the use of these products.

Whipple Industries reserves the right to determine whether the terms of the warranty, set out above, have been properly complied with. In the event that the terms are not complied with, Whipple Industries shall be under no obligation to honor this warranty. By signing this form, you understand and agree to the terms above.

NAME (Print) _____ ADDRESS _____

SIGNATURE _____ CITY _____ STATE _____ ZIP _____

DATE _____ PHONE _____

SC SERIAL # _____ EMAIL _____
(Found on compressor bearing plate) (Optional)

VIN # _____

CONGRATULATIONS

Your new Whipple Supercharger is engineered to significantly increase your engines power across a broad range of RPM's. It is Whipple and Ford Racings goal to improve your driving experience for many miles and years to come.

Whipple Superchargers operate as an air pump and contain internal rotors that are driven by the engine's crankshaft and serpentine belts. The supercharger compresses outside air and channels it into the engine's intake ports. Because of their design, superchargers may generate some additional noise over the standard, normally aspirated induction system.

At idle, you may hear a medium-pitch rattle from the supercharger main housing. This will diminish at about 400-500 rpm above idle.

You may also experience a muffled high-pitched whine during acceleration. This is caused by the pumping action of the supercharger compressing air and only occurs during boost conditions. It is inaudible during part-throttle acceleration.

These are normal noises associated with any supercharger and have no effect on supercharger performance or engine durability.

Your supercharger is warranted by Whipple Superchargers, please see your terms and conditions on the back of your invoice for more information in regards to the limited warranty. NOTE: Whipple Superchargers will not authorize any warranty repair work or supercharger replacement for normal noises.