



Part Number: M-5230-M8SBV,M8TBV,M4SBV and M4TBV
2015 Mustang GT Axle Back Exhaust System with GT 350 Rear Lower Valance
INSTALLATION INSTRUCTIONS

NO PART OF THIS DOCUMENT MAY BE REPRODUCED WITHOUT PRIOR AGREEMENT AND WRITTEN PERMISSION OF
FORD PERFORMANCE PARTS.

Please visit www.fordracingparts.com for the most current instruction information

!!! PLEASE READ ALL OF THE FOLLOWING INSTRUCTIONS CAREFULLY PRIOR TO INSTALLATION. AT ANY TIME YOU DO NOT UNDERSTAND THE INSTRUCTIONS, PLEASE CALL THE FORD PERFORMANCE TECHLINE AT 1-800-367-3788 !!!

OVERVIEW:

The use of a floor hoist is recommended for this installation. If you do not have access to one, use a hydraulic floor jack and jack stands to raise the vehicle.

!! CAUTION: JACK STANDS MUST BE USED ON A LEVEL SURFACE AND BE SECURELY SEATED. FAILURE TO DO SO MAY RESULT IN PERSONAL INJURY OR VEHICLE DAMAGE !!

KIT INCLUDES:

<u>Item #</u>	<u>Qty:</u>	<u>Description</u>
Part of Kit	2	Muffler
Part of Kit	2	Clamp
FR3V-17F954-AF5YZ9	1	Rear Valance

Factory Ford shop manuals are available from Helm Publications, 1-800-782-4356



FORD PERFORMANCE

Part Number: M-5230-M8SBV,M8TBV,M4SBV and M4TBV
2015 Mustang GT Axle Back Exhaust System with GT 350 Rear Lower Valance
INSTALLATION INSTRUCTIONS

Image of New Axle Back Exhaust System:

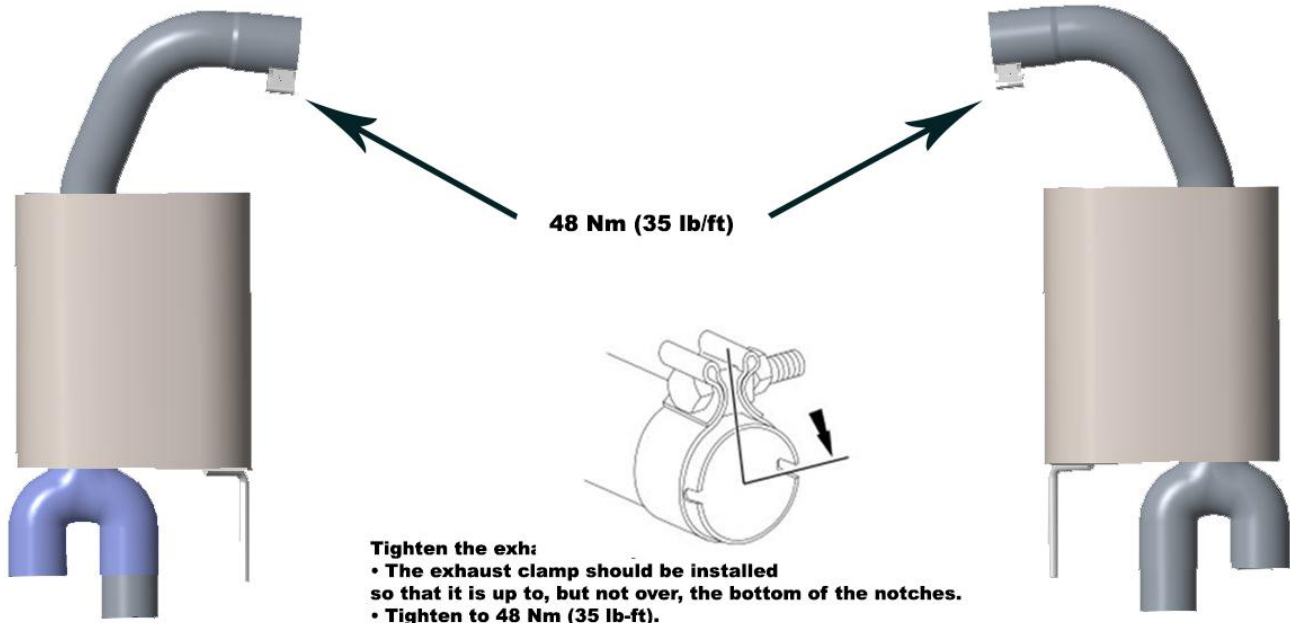

Factory Ford shop manuals are available from Helm Publications, 1-800-782-4356



FORD PERFORMANCE

Part Number: M-5230-M8SBV,M8TBV,M4SBV and M4TBV
2015 Mustang GT Axle Back Exhaust System with GT 350 Rear Lower Valance
INSTALLATION INSTRUCTIONS

Image of Production Exhaust System:

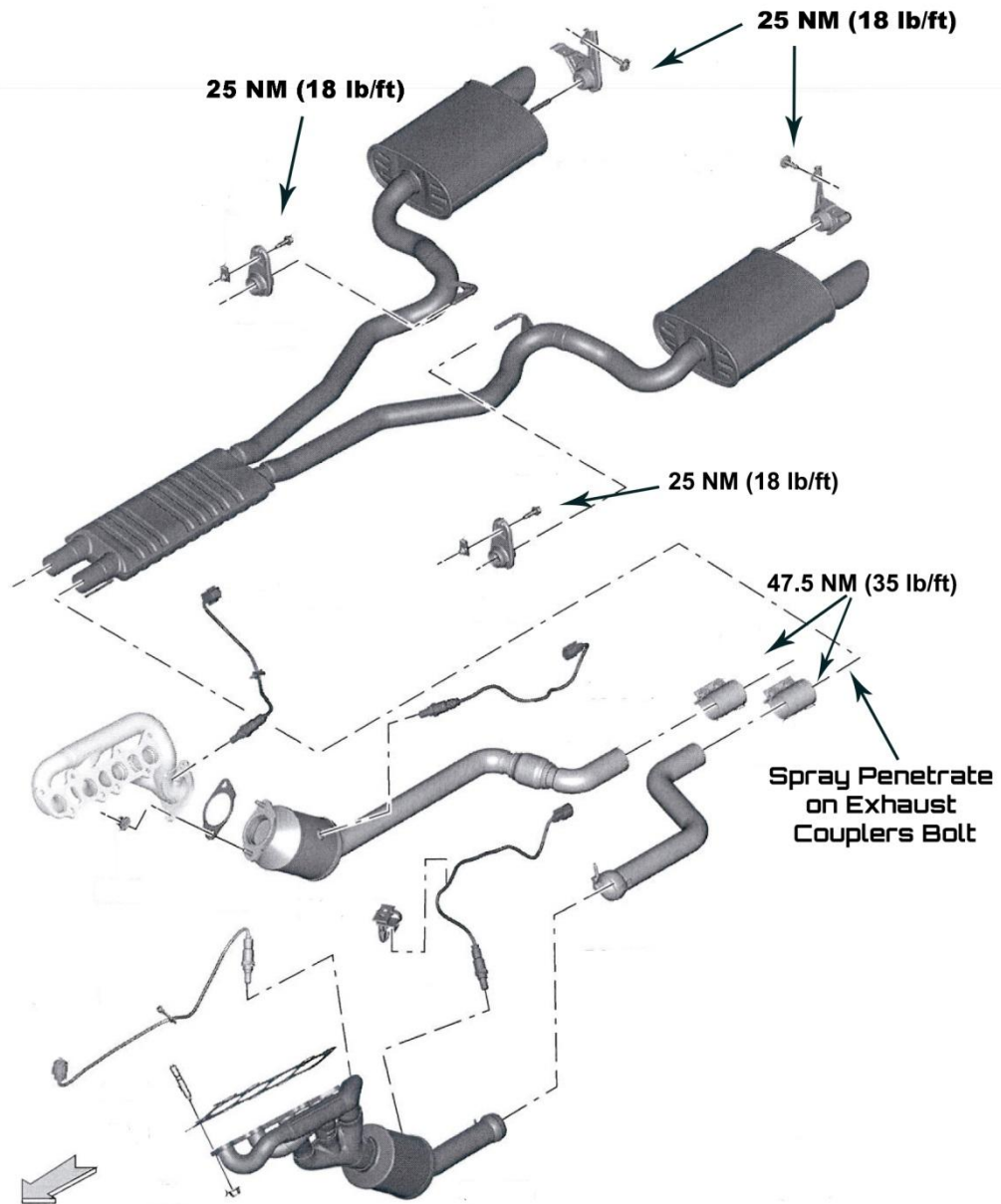

Factory Ford shop manuals are available from Helm Publications, 1-800-782-4356

INSTALLATION INSTRUCTIONS:

STEP 1: Rise and support vehicle.

STEP 2: Mark both drivers and passenger intermediate pipes before the last bend to muffler. (See Fig. 1 and 2)

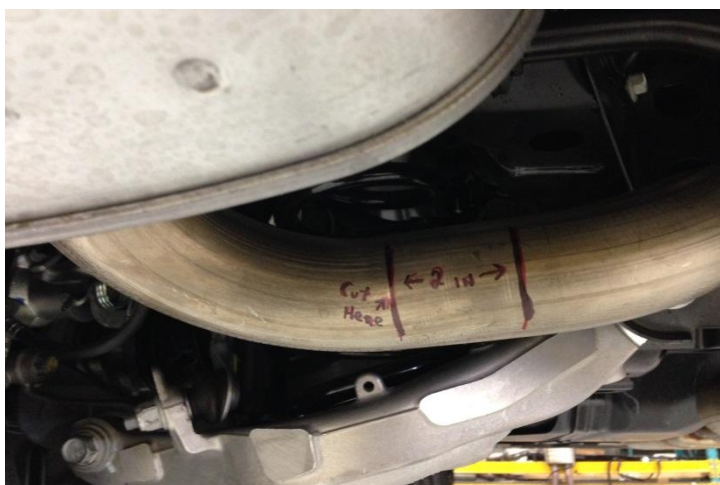

Fig. 1

Drivers side muffler (Cut line is the start of the bend going into the muffler)



Fig. 2

Passenger side muffler (Cut line is the start of the bend going into the muffler)

STEP 3: Using a metal cutting saw cut both drivers and passenger intermediate pipes at cut lines. (See Fig. 3)



Fig. 3

STEP 4: After cutting is completed remove muffler from rear hanger, deburr intermediate pipe. (See Fig. 4)



Fig. 4

Rear Bumper Cover Removal

Step 5: Remove the push pins.

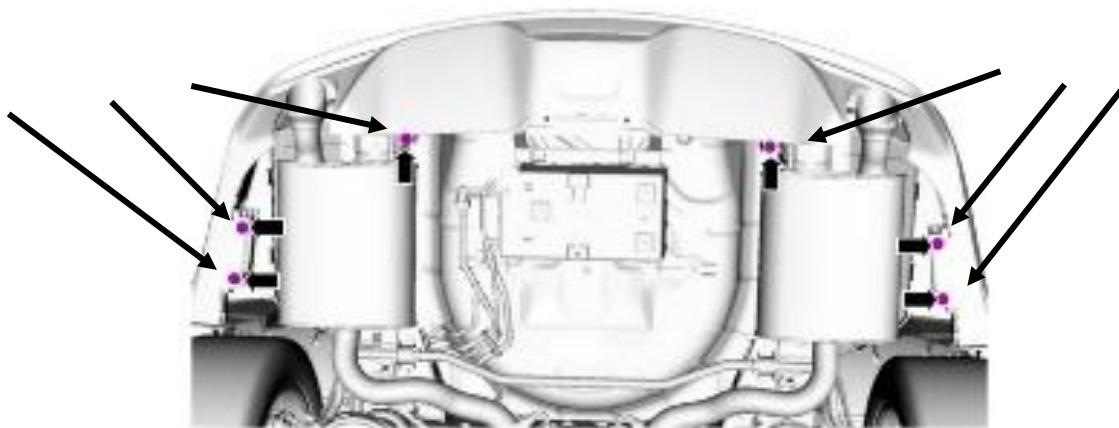

E180136

Step 6: **NOTE:** *On both sides.*

Disconnect the rear bumper harness electrical connector and separate the wiring harness guide.

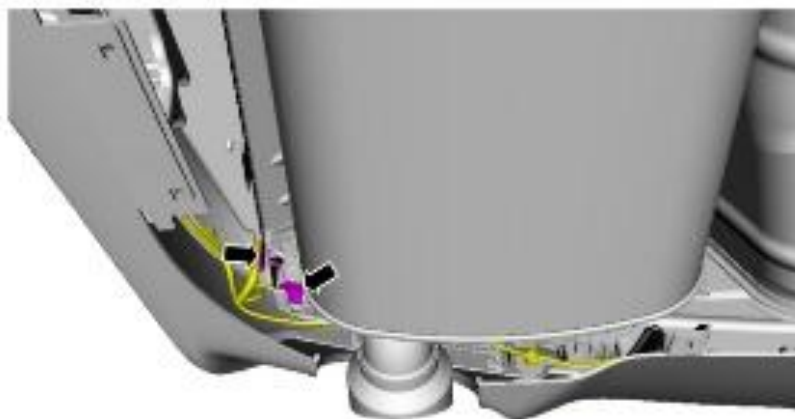

E180132

Step 7: Remove the rear wheels and tires.

Step 8: **NOTE:** *On both sides.*

Remove the screw and the pushpins.

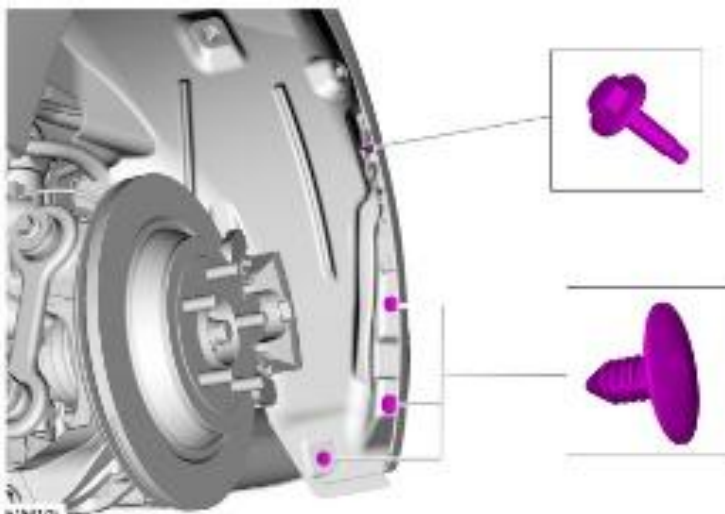

Step 9: Remove the bumper cover to bracket screws. (Two on each side)
Torque: 13 lb.in (1.5 Nm)



Step 10: Remove the rear lamp assemblies.

Step 11: Position the rear bumper cover aside for access to electrical connector.

1. Release the sides of the rear bumper cover from the brackets.
2. Release the center of the rear bumper cover from the rear brackets and position aside.

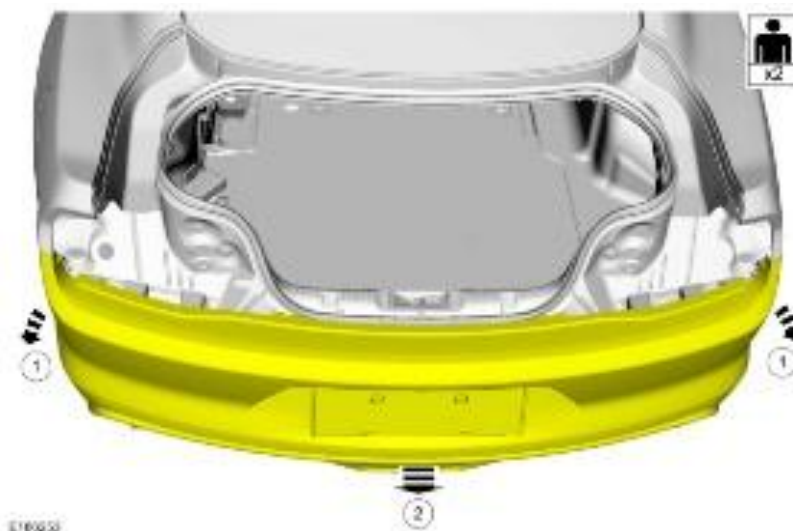

Step 12: Disconnect the rear bumper wiring harness electrical connector.

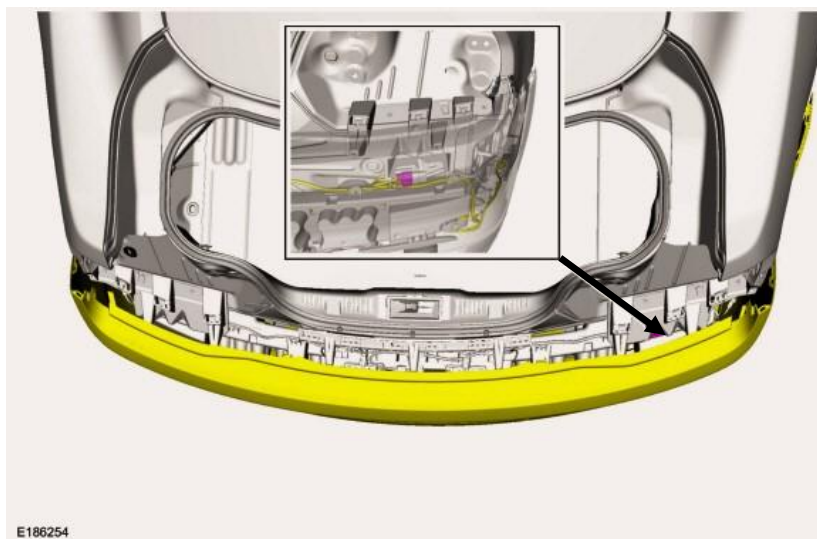

Step 13: Remove the rear bumper cover.



E180036

Step 14: **NOTE:** *On both sides.*

Inspect the side bracket for damage.

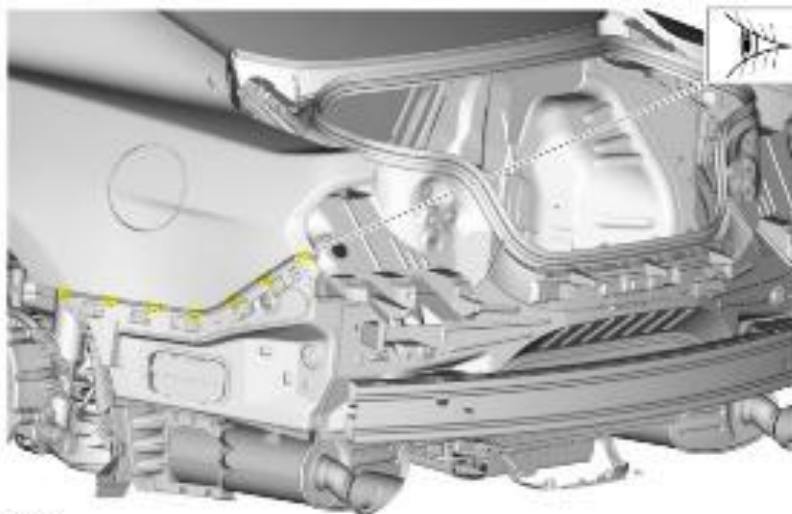

E180032

Step 15: Inspect the rear brackets for damage.

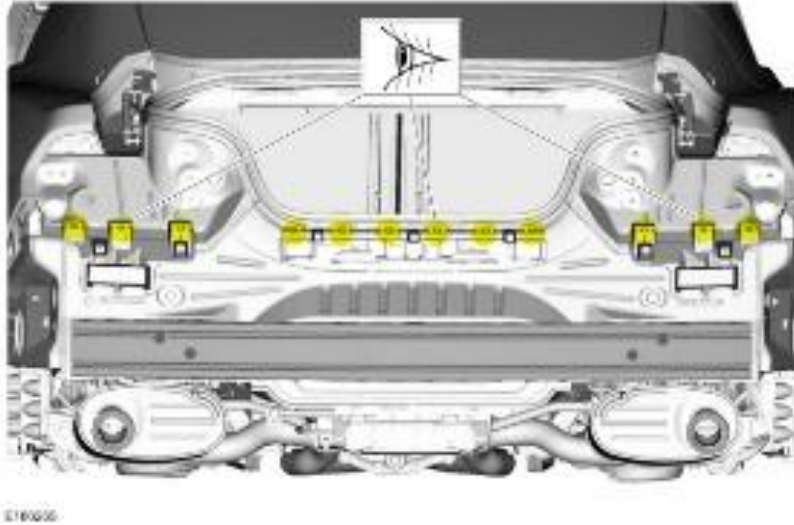

Step 16: If required, remove the screws and the side bracket.
Torque: 13 lb.in (1.5 Nm)

If required, remove the screws and the outer rear bracket.
Torque: 13 lb.in (1.5 Nm)

If required, remove the screws and the center rear bracket.
Torque: 13 lb.in (1.5 Nm)

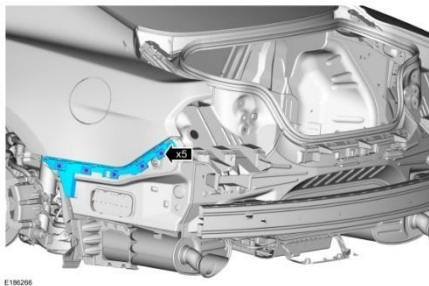

Side

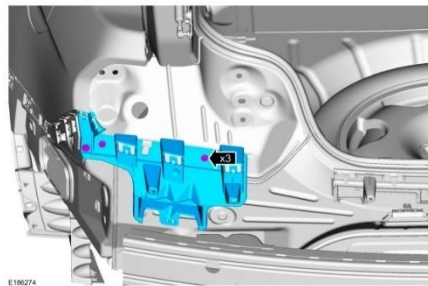

Outer Rear

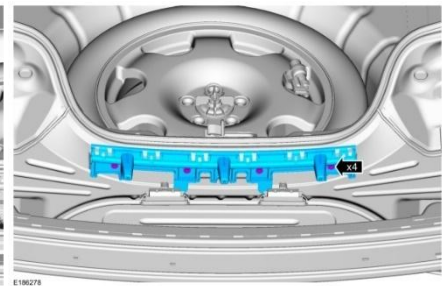

Center Rear

Step 17: Cut rear bumper cover as marked. (Both sides)



Step 18: Install lower valance by snapping into place and installing 3 screws on each side.

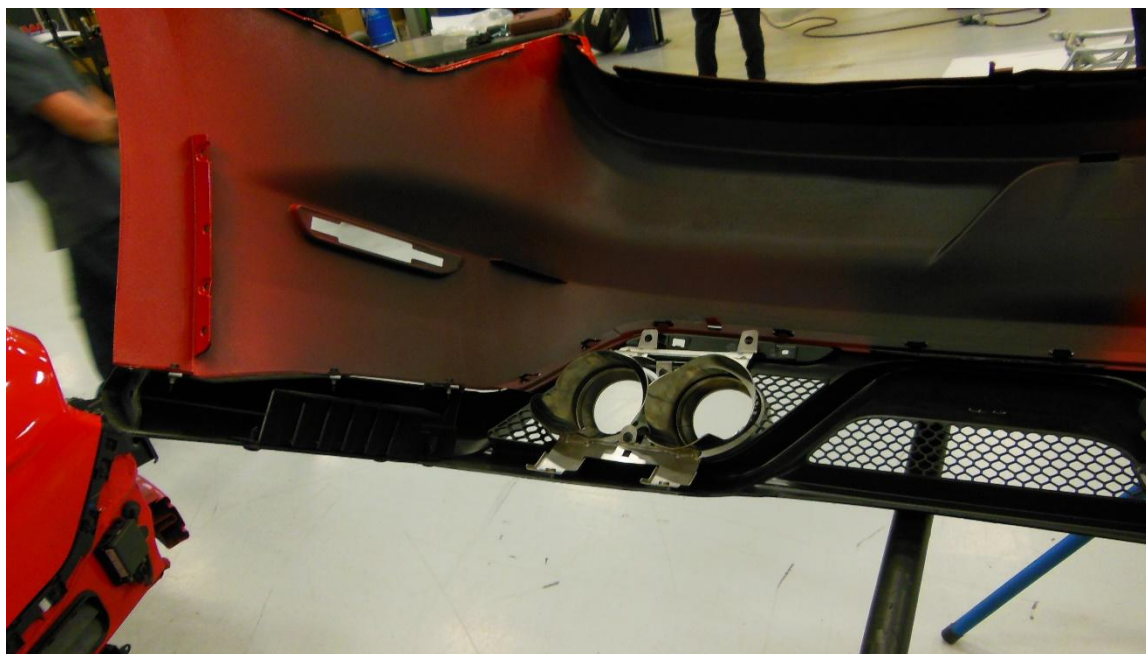

Step 19: Transfer any other hardware from removed bumper cover, if not already installed on bumper cover.



Rear Bumper Cover Installation

To install, reverse the removal procedure.

Step 20: Install supplied clamps onto new mufflers, slide muffler hangers into factory exhaust hangers. Next slide the muffler over the under axle pipes, center muffler in rear bumper opening and tighten clamps to 48 nm (35 lb-ft)

NOTE: *On both sides.*



Step 21: Check all fasteners for proper torque.

Step 22: Check alignment of mufflers in rear bumper cover.



Step 23: Lower vehicle and road test.